

The following overview will help you to locate the channel balances you are looking for. There are three basic classifications: 1. **Non-tilt Balances** 2. **Tilt Balances** 3. **Overhead Balances**. We have designated each of these classifications and have made additional notes to help you determine your specific requirements. For more information, please note the detailed chart page for each individual series.

<p><b>CB 0 Balance</b> Non-Tilt 5/8"</p> <p>9/16" Channel Width</p> <p>5/8" Channel Depth</p> <p>Specify Channel Length</p> <p>Indicate Factory Numbers or Letters Stamped On Balance Face</p> <p>CB9006</p> <p>CB9003</p> <p>Must always have top and bottom guides attached Many guide variations available</p>	<p><b>CB - Caldwell</b> Non-Tilt 5/8"</p> <p>5/8" Channel Width</p> <p>19/32" Channel Depth</p> <p>Specify Channel Length</p> <p>Indicate Factory Numbers or Letters Stamped On Balance Face</p> <p>CB9006-Caldwell</p> <p>CB9003-Caldwell</p> <p>This has a hemmed edge and, in most cases, has an adjustment screw.</p> <p>Tension adjustment screw</p>	<p><b>CB 2 Balance</b> Non Ribbed 5/8"</p> <p>Non ribbed</p> <p>9/16" Channel Width</p> <p>5/8" Channel Depth</p> <p>Specify Channel Length</p> <p>Indicate Factory Numbers or Letters Stamped On Balance Face</p> <p>Comes with CB9062 guide, as shown</p>	<p><b>CB 3 Balance</b> Tilt 5/8"</p> <p>9/16" Channel Width</p> <p>5/8" Channel Depth</p> <p>Specify Channel Length</p> <p>Indicate Factory Numbers or Letters Stamped On Balance Face</p>
<p><b>CB 4 Balance</b> Non-Tilt 3/8"</p> <p>13/32" Channel width</p> <p>3/8" Channel Depth</p> <p>Specify Channel Length</p> <p>Indicate Factory Numbers or Letters Stamped On Balance Face</p> <p>CB9040</p> <p>CB9041</p> <p>3/8" version of the CB 0 Series</p> <p>Must have top and bottom guide attached</p>	<p><b>CB 5 SERIES</b> Tilt 9/16"</p> <p>9/16" Channel Width</p> <p>5/8" Channel Depth</p> <p>Specify Channel Length</p> <p>Indicate Factory Numbers or Letters Stamped On Balance Face</p>	<p><b>CB 6 Balance</b> Tilt 9/16"</p> <p>Ribbed</p> <p>9/16" Channel Width</p> <p>5/8" Channel Depth</p> <p>Specify Channel Length</p> <p>Indicate Factory Numbers or Letters Stamped On Balance Face</p> <p>CB9062</p> <p>CB9066</p>	<p><b>CB1010 Balance</b> Non Tilt For Overhead</p> <p>9/16" Channel Width</p> <p>5/8" Channel Depth</p> <p>Specify Channel Length</p> <p>Used on West Coast</p> <p>Standard cord length is determined from balance to hook at bottom of closed sash</p>

**CB1100 & CB1150  
Invisible Balances**

Mounted in the side of the window sash

Used mainly in custom wood windows when jamb liners will not work

Dacron cord used in newer style

"A" type - single spring  
"AX" type - double spring



**CB1200 Balance  
Bantam**

One of the first overhead balances

Channel Height 5/8"  
Channel Width 9/16"



**CB1600 Balance  
Non-Tilt**

Balance has 2 internal springs

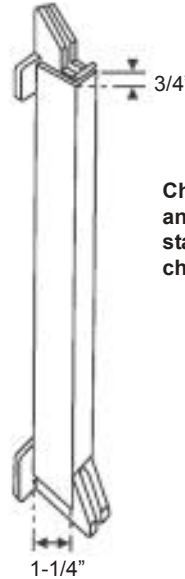

**CB6400 Balance  
Non-Tilt**

Balance has 4 internal springs

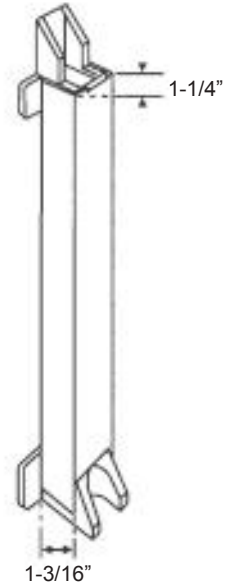

Channel length and weight stamped on channel

**Note: Special order item. Non-returnable**

**CB7400 Balance  
Series Tilt  
Ribbed**

These balances are designed to fit into vinyl jamb liners

End view of channel shape of ribbed balances

CB9295



**CB7700 Balance  
Non-Tilt  
Rusco**



**CB8200 Balance  
Non Tilt for Overhead  
5 to 1 Overhead**

Original design used wire cable. New design uses Dacron Cord

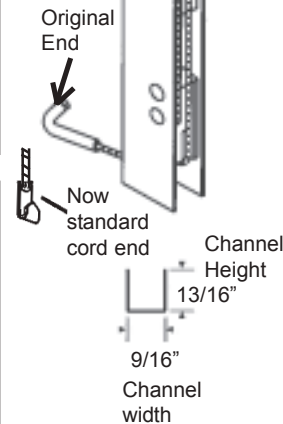

**CB8300 Balance  
Non-Tilt  
Peachtree**

9/16" Channel Width

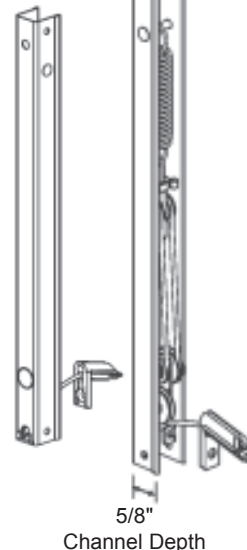

**CB8900 Balance  
Overhead  
Devac Balances**

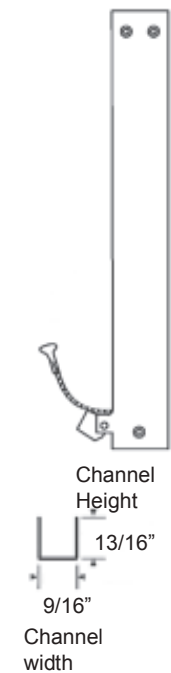

Double Spring Channel

**1/2" Channel Balance**  
Normally 5/8" but considered 1/2" in the industry

\*For 3/8" channel width, refer to  
CB 4 Series balance

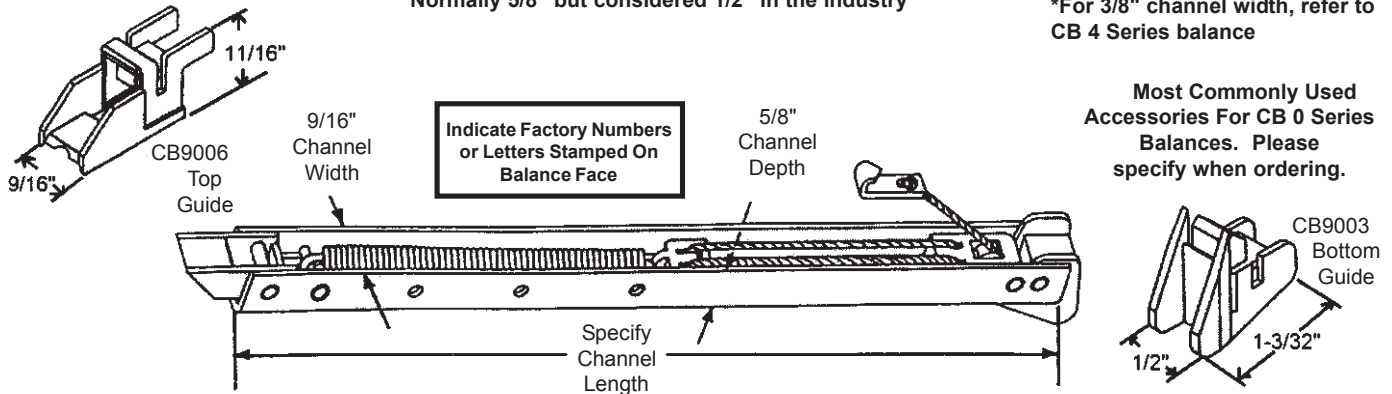

**Most Commonly Used  
Accessories For CB 0 Series  
Balances. Please  
specify when ordering.**

**CB 0 SERIES BALANCE DETAILS**

CHAN- NEL LENGTH	NO. ON BALANCE	BLAINE PART NO.	NO. ON BALANCE	BLAINE PART NO.	NO. ON BALANCE	BLAINE PART NO.	NO. ON BALANCE	BLAINE PART NO.	NO. ON BALANCE	BLAINE PART NO.
7"	610/6A	CB1-610	620/6B	CB1-620	630/6C	CB1-630				
8"	710/7A	CB1-710	720/7B	CB1-720	730/7C	CB1-730				
9"	810/8A	CB1-810	820/8B	CB1-820	830/8C	CB1-830	840/8D	CB1-840		
10"	910/9A	CB1-910	920/9B	CB1-920	930/9C	CB1-930	940/9D	CB1-940		
11"	1010/10A	CB1-1010	1020/10B	CB1-1020	1030/10C	CB1-1030	1040/10D	CB1-1040		
12"	1110/11A	CB1-1110	1120/11B	CB1-1120	1130/11C	CB1-1130	1140/11D	CB1-1140		
13"	1210/101/12A	CB2-1210	1220/102/12B	CB2-1220	1230/103/12C	CB2-1230	1240	CB6		
14"	1310/13A	CB4	1320/13B	CB5	1330/13C	CB5-1330	1340/13D	CB3		
15"	1410/14/14A	CB7	1420/15/14B	CB8	1430/16/14C	CB8-A	1440/14D	CB9		
16"	1510/15A	CB10	1520/15B	CB11	1530/15C	CB11-A	1540/15D	CB12		
17"	1610/111/16A	CB13	1620/112/16B	CB14	1630/113/16C	CB14-A	1640/112HD/16D	CB15		
18"	1710/17A	CB16	1720/17B	CB17	1730/17C	CB17-A	1740/17D	CB18		
19"	1810/18/18A	CB19	1820/19/18B	CB20	1830/20/18C	CB20-A	1840/19HD/18D	CB21		
20"	1910/19A	CB22	1920/19B	CB23	1930/19C	CB23-A	1940/19D	CB24		
21"	2010/121/20A	CB25	2020/122/20B	CB26	2030/123/20C	CB27	2040/123HD/20D	CB28		
22"	2110/21A	CB29	2120/21B	CB30	2130/21C	CB31	2140/21D	CB32		
23"	2210/141/22A	CB33	2220/142/22B	CB34	2230/143/22C	CB35	2240/143HD/22D	CB36		
24"	2310/23A	CB37	2320/23B	CB38	2330/23C	CB39	2340/23D	CB40		
25"	2410/151/24A	CB41	2420/152/24B	CB42	2430/153/24C	CB43	2440/55HD/24D	CB44		
26"	2510/241/25A	CB45	2520/242/25B	CB46	2530/243/25C	CB47	2540/25D	CB48		
27"	2610/161/26A	CB49	2620/162/26B	CB50	2630/163/26C	CB51	2620/163HD/26D	CB52		
28"	2710/27A	CB53	2720/27B	CB54	2730/27C	CB55	2740/27D	CB56		
29"	2810/181/28A	CB57	2820/182/28B	CB58	2830/183/28C	CB59	2840/183HD/28D	CB60	28E/2850	CB60-2850
30"	2910/29A	CB61	2920/29B	CB62	2930/29C	CB63	2940/29D	CB64	29E/2950	CB64-A
31"	3010/191/30A	CB65	3020/192/30B	CB66	3030/193/30C	CB67	3040/193HD/30D	CB68	30E/3050	CB68-A
32"	3110/31A	CB69	3120/31B	CB70	3130/31C	CB71	3140/31D	CB72	31E/3150	CB72-3150
33"	3210/201/32A	CB73	3220/202/32B	CB74	3230/203/32C	CB75	3240/32D	CB76	32E/3250	CB76-HD
34"	3310/33A	CB77	3320/33B	CB78	3330/33C	CB79	3340/33D	CB80	33E/3350	CB80-A
35"	3410/221/34A	CB81	3420/222/34B	CB82	3430/223/34C	CB83	3440/34D	CB84	34E/3450	CB84-A
36"	3510/35A	CB85	3520/35B	CB86	3530/35C	CB87	3540/35D	CB88	35E/3550	CB88-3550
37"	3610/231/36A	CB89	3620/232/36B	CB90	3630/233/36C	CB91	3640/36D	CB92	36E/3650	CB92-3650
38"	3710/37A	CB93	3720/37B	CB94	3730/37C	CB95	3740/37D	CB96	37E/3750	CB96-3950
39"	3810/241/38A	CB97	3820/242/38B	CB98	3830/243/38C	CB99	3840/38D	CB100	38E/3850	CB100-A
40"	3910/39A	CB101	3920/39B	CB102	3930/39C	CB103	3940/39D	CB104	39E/3950	CB104-3950
41"	4010/40A	CB105	4020/40B	CB106	4030/40C	CB107	4040/40D	CB108	40E/4050	CB108-HD
42"	4110/41A	CB109	4120/41B	CB110	4130/41C	CB111	4140/41D	CB112	41E/4150	CB112-4150
43"	4210/261/42A	CB113	4220/262/42B	CB114	4230/263/42C	CB115	4240/42D	CB116	42E/4250	CB116-4250
44"	4310/43A	CB117	4320/43B	CB118	4330/43C	CB119	4340/43D	CB120	43E/4350	CB120-B
45"	4410/271/44A	CB121	4420/272/44B	CB122	4430/273/44C	CB123	4440/44D	CB124	44E/4450	CB124-4550
46"	4510/45A	CB125	4520/45B	CB126	4530/45C	CB127	4540/45D	CB128	45E/4550	CB128-A
47"	4610/281/46A	CB129	4620/282/46B	CB130	4630/283/46C	CB131	4640/46D	CB132	46E/4650	CB132-A
48"	4710/47A	CB133	4720/47B	CB134	4730/47C	CB135	4740/47D	CB136	47E/4750	CB136-4750
49"	4810/291/48A	CB137	4820/292/48B	CB138	4830/293/48C	CB139	4840/48D	CB140	48E/4850	CB140-4850
50"	4910/49A	CB141	4920/49B	CB142	4930/49C	CB143	4940/49D	CB144	49E/4950	CB144-4950
51"									50E/5050	CB148-5050
52"									51E/5150	CB152-5150
53"									52E/5250	CB156-5250
54"									53E/5350	CB160-5350

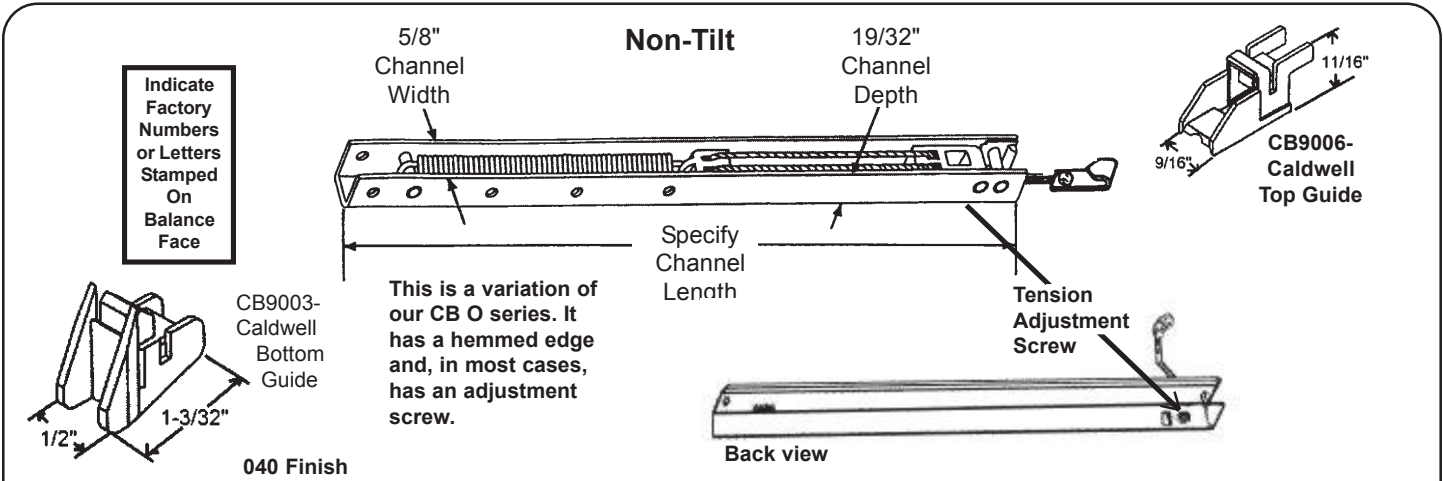

Channel Length	No. Stamp'd On Bal.	Blaine Part Number	Channel Length	No. Stamp'd On Bal.	Blaine Part Number	Channel Length	No. Stamp'd On Bal.	Blaine Part Number	Channel Length	No. Stamp'd On Bal.	Blaine Part Number
13	12-1	CB0002-Cald-12-1	22	21-1	CB0029-Cald-21-1	31	30-1	CB0065-Cald-30-1	40	39-1	CB0101-Cald-39-1
	12-2	CB0002-Cald-12-2		21-2	CB0030-Cald-21-2		30-2	CB0066-Cald-30-2		39-2	CB0102-Cald-39-2
	12-3	CB0002-Cald-12-3		21-3	CB0031-Cald-21-3		30-3	CB0068-Cald-30-3		39-3	CB0103-Cald-39-3
	12-4	CB0002-Cald-12-4		21-4	CB0032-Cald-21-4		30-4	CB0068-Cald-30-4		39-4	CB0104-Cald-39-4
	12-5	CB0002-Cald-12-5		21-5	CB0032-Cald-21-5		30-5	CB0068-Cald-30-5		39-5	CB0104-Cald-39-5
14	13-1	CB0005-Cald-13-1	23	22-1	CB0033-Cald-22-1	32	31-1	CB0069-Cald-31-1	41	40-1	CB0105-Cald-40-1
	13-2	CB0005-Cald-13-2		22-2	CB0034-Cald-22-2		31-2	CB0070-Cald-31-2		40-2	CB0106-Cald-40-2
	13-3	CB0005-Cald-13-3		22-3	CB0035-Cald-22-3		31-3	CB0071-Cald-31-3		40-3	CB0107-Cald-40-3
	13-4	CB0006-Cald-13-4		22-4	CB0036-Cald-22-4		31-4	CB0072-Cald-31-4		40-4	CB0108-Cald-40-4
	13-5	CB0006-Cald-13-5		22-5	CB0036-Cald-22-5		31-5	CB0072-Cald-31-5		40-5	CB0108-Cald-40-5
15	14-1	CB0008-Cald-14-1	24	23-1	CB0037-Cald-23-1	33	32-1	CB0073-Cald-32-1	42	41-1	CB0109-Cald-41-1
	14-2	CB0008-Cald-14-2		23-2	CB0038-Cald-23-2		32-2	CB0074-Cald-32-2		41-2	CB0110-Cald-41-2
	14-3	CB0008-Cald-14-3		23-3	CB0039-Cald-23-3		32-3	CB0075-Cald-32-3		41-3	CB0111-Cald-41-3
	14-4	CB0009-Cald-14-4		23-4	CB0040-Cald-23-4		32-4	CB0076-Cald-32-4		41-4	CB0112-Cald-41-4
	14-5	CB0009-Cald-14-5		23-5	CB0040-Cald-23-5		32-5	CB0076-Cald-32-5		41-5	CB0112-Cald-41-5
16	15-1	CB0010-Cald-15-1	25	24-1	CB0041-Cald-24-1	34	33-1	CB0077-Cald-33-1	43	42-1	CB0113-Cald-42-1
	15-2	CB0011-Cald-15-2		24-2	CB0042-Cald-24-2		33-2	CB0078-Cald-33-2		42-2	CB0114-Cald-42-2
	15-3	CB0011-Cald-15-3		24-3	CB0043-Cald-24-3		33-3	CB0080-Cald-33-3		42-3	CB0115-Cald-42-3
	15-4	CB0012-Cald-15-4		24-4	CB0044-Cald-24-4		33-4	CB0080-Cald-33-4		42-4	CB0116-Cald-42-4
	15-5	CB0012-Cald-15-5		24-5	CB0044-Cald-24-5		33-5	CB0080-Cald-33-5		42-5	CB0116-Cald-42-5
17	16-1	CB0014-Cald-16-1	26	25-1	CB0045-Cald-25-1	35	34-1	CB0081-Cald-34-1	44	43-1	CB0117-Cald-43-1
	16-2	CB0014-Cald-16-2		25-2	CB0046-Cald-25-2		34-2	CB0082-Cald-34-2		43-2	CB0118-Cald-43-2
	16-3	CB0015-Cald-16-3		25-3	CB0047-Cald-25-3		34-3	CB0083-Cald-34-3		43-3	CB0119-Cald-43-3
	16-4	CB0015-Cald-16-4		25-4	CB0048-Cald-25-4		34-4	CB0083-Cald-34-4		43-4	CB0120-Cald-43-4
	16-5	CB0015-Cald-16-5		25-5	CB0048-Cald-25-5		34-5	CB0084-Cald-34-5		43-5	CB0120-Cald-43-5
18	17-1	CB0016-Cald-17-1	27	26-1	CB0049-Cald-26-1	36	35-1	CB0085-Cald-35-1	45	44-1	CB0121-Cald-44-1
	17-2	CB0017-Cald-17-2		26-2	CB0050-Cald-26-2		35-2	CB0086-Cald-35-2		44-2	CB0122-Cald-44-2
	17-3	CB0017-Cald-17-3		26-3	CB0051-Cald-26-3		35-3	CB0087-Cald-35-3		44-3	CB0123-Cald-44-3
	17-4	CB0018-Cald-17-4		26-4	CB0052-Cald-26-4		35-4	CB0088-Cald-35-4		44-4	CB0124-Cald-44-4
	17-5	CB0018-Cald-17-5		26-5	CB0052-Cald-26-5		35-5	CB0088-Cald-35-5		44-5	CB0124-Cald-44-5
19	18-1	CB0019-Cald-18-1	28	27-1	CB0053-Cald-27-1	37	36-1	CB0089-Cald-36-1	36-5		
	18-2	CB0020-Cald-18-2		27-2	CB0054-Cald-27-2		36-2	CB0090-Cald-36-2			
	18-3	CB0020-Cald-18-3		27-3	CB0055-Cald-27-3		36-3	CB0091-Cald-36-3			
	18-4	CB0021-Cald-18-4		27-4	CB0056-Cald-27-4		36-4	CB0092-Cald-36-4			
	18-5	CB0021-Cald-18-5		27-5	CB0056-Cald-27-5		36-5	CB0092-Cald-36-5			
20	19-1	CB0022-Cald-19-1	29	28-1	CB0057-Cald-28-1	38	37-1	CB0093-Cald-37-1	37-5		
	19-2	CB0023-Cald-19-2		28-2	CB0058-Cald-28-2		37-2	CB0094-Cald-37-2			
	19-3	CB0023-Cald-19-3		28-3	CB0059-Cald-28-3		37-3	CB0095-Cald-37-3			
	19-4	CB0024-Cald-19-4		28-4	CB0059-Cald-28-4		37-4	CB0096-Cald-37-4			
	19-5	CB0024-Cald-19-5		28-5	CB0060-Cald-28-5		37-5	CB0096-Cald-37-5			
21	20-1	CB0025-Cald-20-1	30	29-1	CB0061-Cald-29-1	39	38-1	CB0097-Cald-38-1	38-5		
	20-2	CB0026-Cald-20-2		29-2	CB0062-Cald-29-2		38-2	CB0098-Cald-38-2			
	20-3	CB0027-Cald-20-3		29-3	CB0063-Cald-29-3		38-3	CB0099-Cald-38-3			
	20-4	CB0028-Cald-20-4		29-4	CB0064-Cald-29-4		38-4	CB0100-Cald-38-4			
	20-5	CB0028-Cald-20-5		29-5	CB0064-Cald-29-5		38-5	CB0100-Cald-38-5			

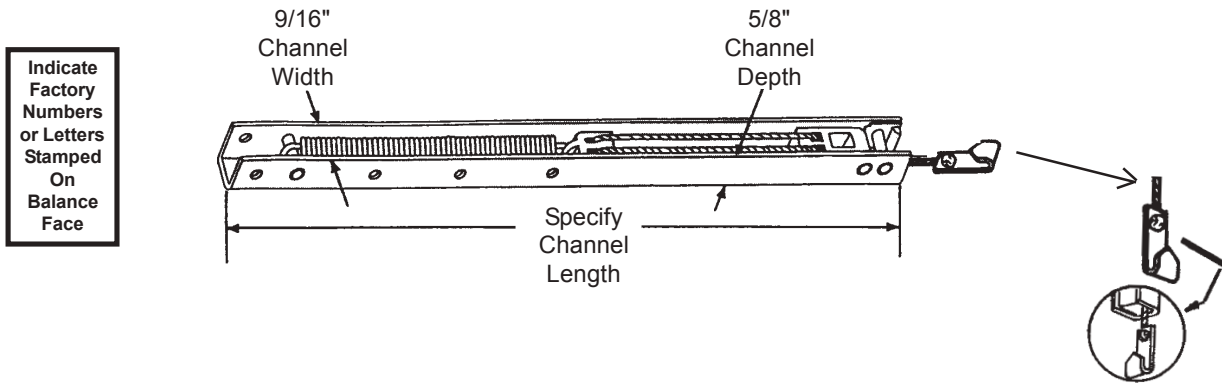

Length of Metal Channel	No. Stamped On Bal.	Blaine Part Number	No. Stamped On Bal.	Blaine Part Number	No. Stamped On Bal.	Blaine Part Number	No. Stamped On Bal.	Blaine Part Number
13	1210 or 13A	CB3001-040	1220 or 13B	CB3002-040	1230 or 13C	CB3001-13C	1240 or 13D	CB3001-13D
14	1310 or 14A	CB3003-040	1320 or 14B	CB3004-040	1330 or 14C	CB3004-14C	1340 or 14D	CB3004-14D
15	1410 or 15A	CB3005-040	1420 or 15B	CB3006-040	1430 or 15C	CB3006-15C	1440 or 15D	CB3006-15D
16	1510 or 16A	CB3007-040	1520 or 16B	CB3008-040	1530 or 16C	CB3008-16C	1540 or 16D	CB3008-16D
17	1610 or 17A	CB3009-040	1620 or 17B	CB3010-040	1630 or 17C	CB3010-17C	1640 or 17D	CB3010-17D
18	1710 or 18A	CB3011-040	1720 or 18B	CB3012-040	1730 or 18C	CB3012-18C	1740 or 18D	CB3012-18D
19	1810 or 19A	CB3013-040	1820 or 19B	CB3014-040	1830 or 19C	CB3014-19C	1840 or 19D	CB3014-19D
20	1910 or 20A	CB3015-040	1920 or 20B	CB3016-040	1930 or 20C	CB3016-20C	1940 or 20D	CB3016-20D
21	2010 or 21A	CB3017-040	2020 or 21B	CB3018-040	2030 or 21C	CB3019-040	2040 or 21D	CB3019-21D
22	2110 or 22A	CB3020-040	2120 or 22B	CB3021-040	2130 or 22C	CB3021-22C	2140 or 22D	CB3022-040
23	2210 or 23A	CB3023-040	2220 or 23B	CB3024-040	2230 or 23C	CB3025-23C	2240 or 23D	CB3025-23D
24	2310 or 24A	CB3026-040	2320 or 24B	CB3027-040	2330 or 24C	CB3028-040	2340 or 24D	CB3028-24D
25	2410 or 25A	CB3029-040	2420 or 25B	CB3030-040	2430 or 25C	CB3030-25C	2440 or 25D	CB3030-25D
26	2510 or 26A	CB3032-040	2520 or 26B	CB3033-040	2530 or 26C	CB3034-040	2540 or 26D	CB3034-26D
27	2610 or 27A	CB3035-040	2620 or 27B	CB3036-040	2630 or 27C	CB3037-040	2640 or 27D	CB3037-27D
28	2710 or 28A	CB3038-040	2720 or 28B	CB3039-040	2730 or 28C	CB3040-040	2740 or 28D	CB3040-28D
29	2810 or 29A	CB3041-040	2820 or 29B	CB3042-040	2830 or 29C	CB3043-040	2840 or 29D	CB3043-29D
30	2910 or 30A	CB3044-040	2920 or 30B	CB3045-040	2930 or 30C	CB3046-040	2940 or 30D	CB3046-30D
31	3010 or 31A	CB3047-040	3020 or 31B	CB3048-040	3030 or 31C	CB3049-040	3040 or 31D	CB3049-31D
32	3110 or 32A	CB3050-040	3120 or 32B	CB3051-040	3130 or 32C	CB3052-040	3140 or 32D	CB3052-32D
33	3210 or 33A	CB3053-040	3220 or 33B	CB3054-040	3230 or 33C	CB3055-040	3240 or 33D	CB3055-33D
34	3310 or 34A	CB3056-040	3320 or 34B	CB3057-040	3330 or 34C	CB3058-040	3340 or 34D	CB3058-34D
35	3410 or 35A	CB3059-040	3420 or 35B	CB3060-040	3430 or 35C	CB3061-040	3440 or 35D	CB3061-35D
36	3510 or 36A	CB3062-040	3520 or 36B	CB3063-040	3530 or 36C	CB3064-040	3540 or 36D	CB3064-36D
37	3610 or 37A	CB3065-040	3620 or 37B	CB3066-040	3630 or 37C	CB3067-040	3640 or 37D	CB3067-37D
38	3710 or 38A	CB3068-040	3720 or 38B	CB3069-040	3730 or 38C	CB3070-040	3740 or 38D	CB3070-38D
39	3810 or 39A	CB3071-040	3820 or 39B	CB3072-040	3830 or 39C	CB3073-040	3840 or 39D	CB3073-39D
40	3910 or 40A	CB3074-040	3920 or 40B	CB3075-040	3930 or 40C	CB3076-040	3940 or 40D	CB3076-40D
41	4010 or 41A	CB3077-040	4020 or 41B	CB3078-040	4030 or 41C	CB3079-040	4040 or 41D	CB3079-41D
42	4110 or 42A	CB3080-040	4120 or 42B	CB3081-040	4130 or 42C	CB3082-040	4140 or 42D	CB3082-42D
43	4210 or 43A	CB3083-040	4220 or 43B	CB3084-040	4230 or 43C	CB3085-040	4240 or 43D	CB3085-43D
44	4310 or 44A	CB3086-040	4320 or 44B	CB3087-040	4330 or 44C	CB3088-040	4340 or 44D	CB3088-44D

**3/8" Channel Balance - Non Tilt**

Most Commonly Used  
Accessories For CB 4 Series  
Balances

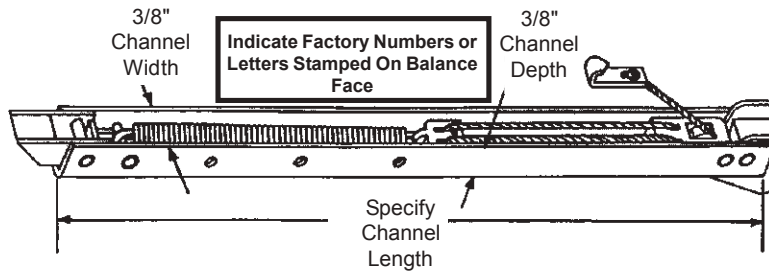
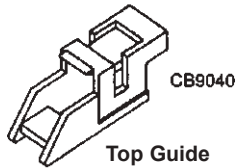

Bottom Guide

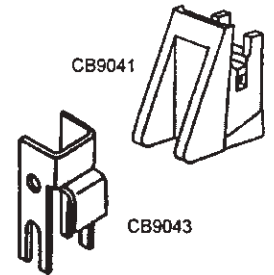

Length of Metal Channel	No. Stamped On Bal.	BWH Part No.	Length of Metal Channel	No. Stamped On Bal.	BWH Part No.	Length of Metal Channel	No. Stamped On Bal.	BWH Part No.
11	10A	CB4001	11	10B	CB4002	11	10C	CB4003
12	11A	CB4004	12	11B	CB4005	12	11C	CB4006
13	12A	CB4007	13	12B	CB4008	13	12C	CB4009
14	13A	CB4010	14	13B	CB4011	14	13C	CB4012
15	14A	CB4013	15	14B	CB4014	15	14C	CB4015
16	15A	CB4016	16	15B	CB4017	16	15C	CB4018
17	16A	CB4019	17	16B	CB4020	17	16C	CB4021
18	17A	CB4022	18	17B	CB4023	18	17C	CB4024
19	18A	CB4025	19	18B	CB4026	19	18C	CB4027
20	19A	CB4028	20	19B	CB4029	20	19C	CB4030
21	20A	CB4031	21	20B	CB4032	21	20C	CB4033
22	21A	CB4034	22	21B	CB4035	22	21C	CB4036
23	22A	CB4037	23	22B	CB4038	23	22C	CB4039
24	23A	CB4040	24	23B	CB4041	24	23C	CB4042
25	24A	CB4043	25	24B	CB4044	25	24C	CB4045
26	25A	CB4046	26	25B	CB4047	26	25C	CB4048
27	26A	CB4049	27	26B	CB4050	27	26C	CB4051
28	27A	CB4052	28	27B	CB4053	28	27C	CB4054
29	28A	CB4055	29	28B	CB4056	29	28C	CB4057
30	29A	CB4058	30	29B	CB4059	30	29C	CB4060
31	30A	CB4061	31	30B	CB4062	31	30C	CB4063
32	31A	CB4064	32	31B	CB4065	32	31C	CB4066
33	32A	CB4067	33	32B	CB4068	33	32C	CB4069
34	33A	CB4070	34	33B	CB4071	34	33C	CB4072
35	34A	CB4073	35	34B	CB4074	35	34C	CB4075
36	35A	CB4076	36	35B	CB4077	36	35C	CB4078
37	36A	CB4079	37	36B	CB4080	37	36C	CB4081
38	37A	CB4082	38	37B	CB4083	38	37C	CB4084

**Balance Accessories**

Top Bracket

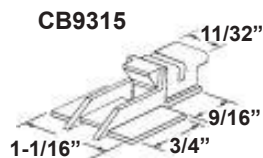

Bottom Brackets



Sash Guides

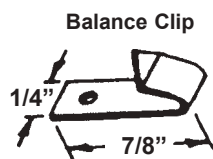

Rivet

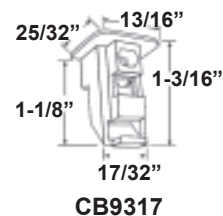
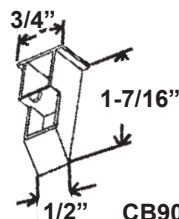

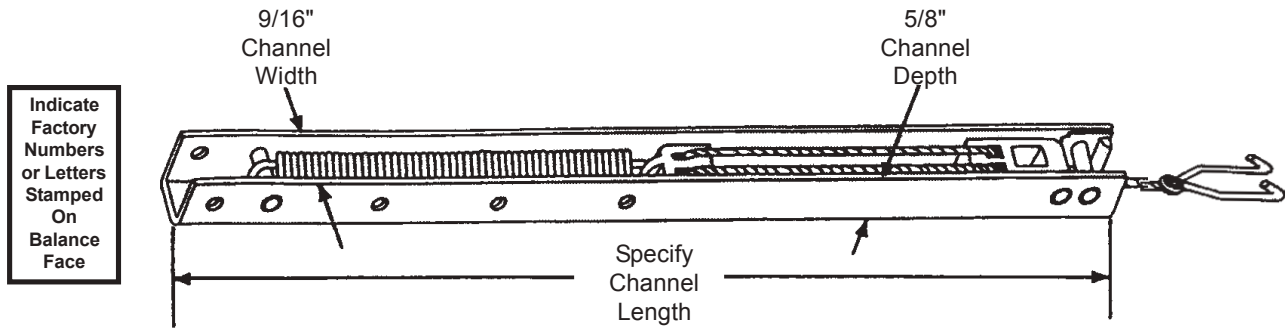

**Ordering Information:**

1. Measure metal channel length .
2. Locate number stamped on balance (e.g., 1410, 2510, 26A, etc. . .)
3. Refer to chart, below, to locate the proper balance which corresponds to the numbers.

Length of Metal Channel	No. Stamped On Bal.	Blaine Part Number	No. Stamped On Bal.	Blaine Part Number	No. Stamped On Bal.	Blaine Part Number	No. Stamped On Bal.	Blaine Part Number
13	1210 or 13A	CB5001-13A-040	1220 or 13B	CB5001-13B-040	1230 or 13C	CB5002-13C-040	1240 or 13D	CB5002-13D-040
14	1310 or 14A	CB5003-14A-040	1320 or 14B	CB5004-14B-040	1330 or 14C	CB5004-14C-040	1340 or 14D	CB5004-14D-040
15	1410 or 15A	CB5005-15A-040	1420 or 15B	CB5006-15B-040	1430 or 15C	CB5006-15C-040	1440 or 15D	CB5006-15D-040
16	1510 or 16A	CB5007-16A-040	1520 or 16B	CB5008-16B-040	1530 or 16C	CB5008-16C-040	1540 or 16D	CB5008-16D-040
17	1610 or 17A	CB5009-17A-040	1620 or 17B	CB5010-17B-040	1630 or 17C	CB5010-17C-040	1640 or 17D	CB5010-17D-040
18	1710 or 18A	CB5011-18A-040	1720 or 18B	CB5012-18B-040	1730 or 18C	CB5012-18C-040	1740 or 18D	CB5012-18D-040
19	1810 or 19A	CB5013-19A-040	1820 or 19B	CB5014-19B-040	1830 or 19C	CB5014-19C-040	1840 or 19D	CB5014-19D-040
20	1910 or 20A	CB5015-20A-040	1920 or 20B	CB5016-20B-040	1930 or 20C	CB5016-20C-040	1940 or 20D	CB5016-20D-040
21	2010 or 21A	CB5017-21A-040	2020 or 21B	CB5018-21B-040	2030 or 21C	CB5019-21C-040	2040 or 21D	CB5019-21D-040
22	2110 or 22A	CB5020-22A-040	2120 or 22B	CB5021-22B-040	2130 or 22C	CB5021-22C-040	2140 or 22D	CB5022-22D-040
23	2210 or 23A	CB5023-23A-040	2220 or 23B	CB5024-23B-040	2230 or 23C	CB5025-23C-040	2240 or 23D	CB5025-23D-040
24	2310 or 24A	CB5026-24A-040	2320 or 24B	CB5027-24B-040	2330 or 24C	CB5028-24C-040	2340 or 24D	CB5028-24D-040
25	2410 or 25A	CB5029-25A-040	2420 or 25B	CB5030-25B-040	2430 or 25C	CB5030-25C-040	2440 or 25D	CB5031-25D-040
26	2510 or 26A	CB5032-26A-040	2520 or 26B	CB5033-26B-040	2530 or 26C	CB5034-26C-040	2540 or 26D	CB5034-26D-040
27	2610 or 27A	CB5035-27A-040	2620 or 27B	CB5036-27B-040	2630 or 27C	CB5037-27C-040	2640 or 27D	CB5037-27D-040
28	2710 or 28A	CB5038-28A-040	2720 or 28B	CB5039-28B-040	2730 or 28C	CB5040-28C-040	2740 or 28D	CB5040-28D-040
29	2810 or 29A	CB5041-29A-040	2820 or 29B	CB5042-29B-040	2830 or 29C	CB5043-29C-040	2840 or 29D	CB5043-29D-040
30	2910 or 30A	CB5044-30A-040	2920 or 30B	CB5045-30B-040	2930 or 30C	CB5046-30C-040	2940 or 30D	CB5046-30D-040
31	3010 or 31A	CB5047-31A-040	3020 or 31B	CB5048-31B-040	3030 or 31C	CB5049-31C-040	3040 or 31D	CB5049-31D-040
32	3110 or 32A	CB5050-32A-040	3120 or 32B	CB5051-32B-040	3130 or 32C	CB5052-32C-040	3140 or 32D	CB5052-32D-040
33	3210 or 33A	CB5053-33A-040	3220 or 33B	CB5054-33B-040	3230 or 33C	CB5055-33C-040	3240 or 33D	CB5055-33D-040
34	3310 or 34A	CB5056-34A-040	3320 or 34B	CB5057-34B-040	3330 or 34C	CB5058-34C-040	3340 or 34D	CB5058-34D-040
35	3410 or 35A	CB5059-35A-040	3420 or 35B	CB5060-35B-040	3430 or 35C	CB5061-35C-040	3440 or 35D	CB5061-35D-040
36	3510 or 36A	CB5062-36A-040	3520 or 36B	CB5063-36B-040	3530 or 36C	CB5064-36C-040	3540 or 36D	CB5064-36D-040
37	3610 or 37A	CB5065-37A-040	3620 or 37B	CB5066-37B-040	3630 or 37C	CB5067-37C-040	3640 or 37D	CB5067-37D-040
38	3710 or 38A	CB5068-38A-040	3720 or 38B	CB5069-38B-040	3730 or 38C	CB5070-38C-040	3740 or 38D	CB5070-38D-040
39	3810 or 39A	CB5071-39A-040	3820 or 39B	CB5072-39B-040	3830 or 39C	CB5073-39C-040	3840 or 39D	CB5073-39D-040
40	3910 or 40A	CB5074-40A-040	3920 or 40B	CB5075-40B-040	3930 or 40C	CB5076-40C-040	3940 or 40D	CB5076-40D-040
41	4010 or 41A	CB5077-41A-040	4020 or 41B	CB5078-41B-040	4030 or 41C	CB5079-41C-040	4040 or 41D	CB5079-41D-040
42	4110 or 42A	CB5080-42A-040	4120 or 42B	CB5081-42B-040	4130 or 42C	CB5082-42C-040	4140 or 42D	CB5082-42D-040
43	4210 or 43A	CB5083-43A-040	4220 or 43B	CB5084-43B-040	4230 or 43C	CB5085-43C-040	4240 or 43D	CB5085-43D-040
44	4310 or 44A	CB5086-44A-040	4320 or 44B	CB5087-44B-040	4330 or 44C	CB5088-44C-040	4340 or 44D	CB5088-44D-040

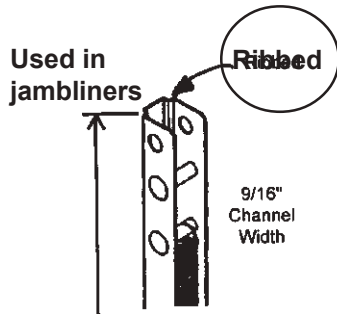
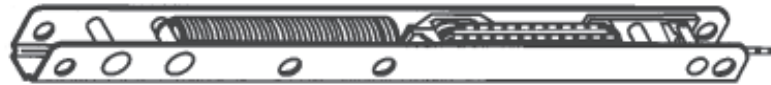

Indicate Factory Numbers or Letters Stamped On Balance Face



**CB9062**

No. Stamped On Balance	Blaine Part No.	No. Stamped On Balance	Blaine Part No.	No. Stamped On Balance	Blaine Part No.	No. Stamped On Balance	Blaine Part No.
12R	CB6012-12R	22R	CB6022-22R	32R	CB6032-32R	42R	CB6042-42R
12HD	CB6012-12HD	22HD	CB6022-22HD	32HD	CB6032-32HD	42HD	CB6042-42HD
12XH	CB6012-12XH	22XH	CB6022-22XH	32XH	CB6032-32XH	42XH	CB6042-42XH
13R	CB6013-13R	23R	CB6023-23R	33R	CB6033-33R	43R	CB6043-43R
13HD	CB6013-13HD	23HD	CB6023-23HD	33HD	CB6033-33HD	43HD	CB6043-43HD
13XH	CB6013-13XH	23XH	CB6023-23XH	33XH	CB6033-33XH	43XH	CB6043-43XH
14R	CB6014-14R	24R	CB6024-24R	34R	CB6034-34R	44R	CB6044-44R
14HD	CB6014-14HD	24HD	CB6024-24HD	34HD	CB6034-34HD	44HD	CB6044-44HD
14XH	CB6014-14XH	24XH	CB6024-24XH	34XH	CB6034-34XH	44XH	CB6044-44XH
15R	CB6015-15R	25R	CB6025-25R	35R	CB6035-35R	45R	CB6045-45R
15HD	CB6015-15HD	25HD	CB6025-25HD	35HD	CB6035-35HD	45HD	CB6045-45HD
15XH	CB6015-15XH	25XH	CB6025-25XH	35XH	CB6035-35XH	45XH	CB6045-45XH
16R	CB6016-16R	26R	CB6026-26R	36R	CB6036-36R	46R	CB6046-46R
16HD	CB6016-16HD	26HD	CB6026-26HD	36HD	CB6036-36HD	46HD	CB6046-46HD
16XH	CB6016-16XH	26XH	CB6026-26XH	36XH	CB6036-36XH	46XH	CB6046-46XH
17R	CB6017-17R	27R	CB6027-27R	37R	CB6037-37R	47R	CB6047-47R
17HD	CB6017-17HD	27HD	CB6027-27HD	37HD	CB6037-37HD	47HD	CB6047-47HD
17XH	CB6017-17XH	27XH	CB6027-27XH	37XH	CB6037-37XH	47XH	CB6047-47XH
18R	CB6018-18R	28R	CB6028-28R	38R	CB6038-38R	48R	CB6048-48R
18HD	CB6018-18HD	28HD	CB6028-28HD	38HD	CB6038-38HD	48HD	CB6048-48HD
18XH	CB6018-18XH	28XH	CB6028-28XH	38XH	CB6038-38XH	48XH	CB6048-48XH
19R	CB6019-19R	29R	CB6029-29R	39R	CB6039-39R	49R	CB6049-49R
19HD	CB6019-19HD	29HD	CB6029-29HD	39HD	CB6039-39HD	49HD	CB6049-49HD
19XH	CB6019-19XH	29XH	CB6029-29XH	39XH	CB6039-39XH	49XH	CB6049-49XH
20R	CB6020-20R	30R	CB6030-30R	40R	CB6040-40R	50R	CB6050-50R
20HD	CB6020-20HD	30HD	CB6030-30HD	40HD	CB6040-40HD	50HD	CB6050-50HD
20XH	CB6020-20XH	30XH	CB6030-30XH	40XH	CB6040-40XH	50XH	CB6050-50XH
21R	CB6021-21R	31R	CB6031-31R	41R	CB6041-41R	51R	CB6051-51R
21HD	CB6021-21HD	31HD	CB6031-31HD	41HD	CB6041-41HD	51HD	CB6051-51HD
21XH	CB6021-21XH	31XH	CB6031-31XH	41XH	CB6041-41XH	51XH	CB6051-51XH



**CB7700 SERIES RUSCO Channel Balance**

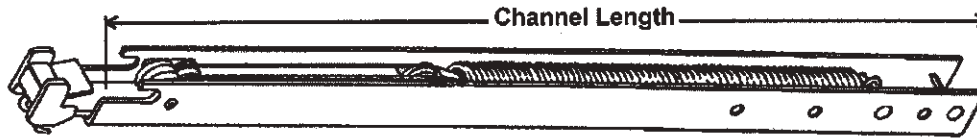

BLAINE PART NO.	NO. STAMPED ON BALANCE	CHANNEL LENGTH	BLAINE PART NO.	NO. STAMPED ON BALANCE	CHANNEL LENGTH
CB7700-10A	10A - C	10-1/2"	CB7700-25C	25C	26"
CB7700-10B	10B - C	10-1/2"	CB7700-25D	25D	26"
CB7700-10D	10D - C	10-1/2"	CB7700-25S	25S	25-5/8"
CB7700-10S	10-S	10-3/16"	CB7700-26C	26C	26-1/2"
CB7700-11A	11A	11-7/8"	CB7700-26S	26S	26-25/32"
CB7700-11B	11B	11-7/8"	CB7700-27A	27A	27-7/8"
CB7700-11D	11D	11-7/8"	CB7700-27B	27B	27-7/8"
CB7700-14A	14A	14-3/8"	CB7700-27C	27C	27-7/8"
CB7700-15A	15A	15-7/8"	CB7700-27D	27D	27-7/8"
CB7700-15B	15B	15-7/8"	CB7700-27E	27E	27-7/8"
CB7700-15D	15D	15-7/8"	CB7700-27S	27S	27-15/16"
CB7700-16A	16A - C	16-11/16"	CB7700-28A	28A - C	29"
CB7700-16B	16B - C	16-11/16"	CB7700-28B	28B - C	29"
CB7700-16D	16D - C	16-11/16"	CB7700-28C	28C - C	29"
CB7700-16E	16E - C	16-11/16"	CB7700-28D	28D - C	29"
CB7700-16F	16F	16-1/8"	CB7700-28E	28E - C	29"
CB7700-16S	16S	16-13/32"	CB7700-28F	28F - C	29"
CB7700-16S-18	16S - 18	16-11/16"	CB7700-28S	28S - 28	28-9/16"
CB7700-17A	17A	18"	CB7700-31B	31B	32"
CB7700-17B	17B	18"	CB7700-31C	31C	32"
CB7700-17C	17C	18"	CB7700-31D	31D	32"
CB7700-17D	17D	18"	CB7700-31E	31E	32"
CB7700-18B	18B	18-1/4"	CB7700-33A	33A	33-7/8"
CB7700-18S	18S	18-21/32"	CB7700-33B	33B	33-7/8"
CB7700-19A	19A	19-7/8"	CB7700-33C	33C	33-7/8"
CB7700-19B	19B	19-7/8"	CB7700-33D	33D	33-7/8"
CB7700-19D	19D	19-7/8"	CB7700-33E	33E	33-7/8"
CB7700-19S	19S	19-7/8"	CB7700-35A - C	35A - C	35-7/8"
CB7700-20C	20C	20-5/8"	CB7700-35B - C	35B - C	35-7/8"
CB7700-20D	20D	20-5/8"	CB7700-35C - C	35C - C	35-7/8"
CB7700-20E	20E	20-3/4"	CB7700-35D - C	35D - C	35-7/8"
CB7700-20S	20S	20-3/8"	CB7700-35E - C	35E - C	35-7/8"
CB7700-21A	21A	21-7/8"	CB7700-39A	39A	39-7/8"
CB7700-21B	21B	21-7/8"	CB7700-39C	39C	39-7/8"
CB7700-21C	21C	21-7/8"	CB7700-39D	39D	39-7/8"
CB7700-21D	21D	21-7/8"	CB7700-39E	39E	39-7/8"
CB7700-21S	21S	21-15/16"	CB7700-42A	42A	42-7/8"
CB7700-22A	22A	22-13/16"	CB7700-42B	42B	42-7/8"
CB7700-22B	22B	22-13/16"	CB7700-42C	42C	42-7/8"
CB7700-22C	22C	22-13/16"	CB7700-42D	42D	42-7/8"
CB7700-22D	22D	22-13/16"	CB7700-42E	42E	42-7/8"
CB7700-22E	22E - C	22-13/16"			
CB7700-22F	22F	22-13/16"			
CB7700-22S	22S - 23	22-9/16"			
CB7700-23A	23A	23-7/8"			
CB7700-23B	23B	23-7/8"			
CB7700-23C	23C	23-7/8"			
CB7700-23D	23D	23-7/8"			
CB7700-23E	23E	24"			
CB7700-23F	23F	24"			
CB7700-23S	23S	23-1/16"			
CB7700-24D	24D	24-3/8"			
CB7700-24F	24F	24-3/8"			
CB7700-24S	24S	24-11/32"			
CB7700-25B	25B	26"			

**CB8300 SERIES PEACHTREE BALANCE**

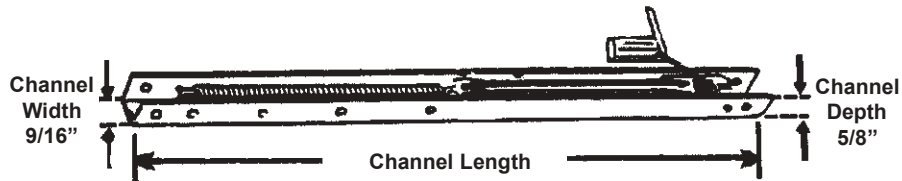

Blaine Part No.	No. Stamped On Balance	Channel Length
CB8300-3036-040	3036-1	14-1/4"
CB8300-3040-040	3040-1	16-1/4"
CB8300-3048-040	3048-1	20-1/4"
CB8300-3054-040	3054-1	23-1/4"
CB8300-3060-040	3060-1	26-1/4"
CB8300-3066-040	3066-1	29-1/4"
CB8300-3072-040	3072-1	32-1/4"
CB8300-3360-040	3360-1	25-1/4"
CB8300-3372-040	3372-1	31-1/4"
CB8300-3636-040	3636-1	14-1/4"
CB8300-3640-040	3640-1	16-1/4"
CB8300-3648-040	3648-1	20-1/4"
CB8300-3654-040	3654-1	23-1/4"
CB8300-3660-040	3660-1	26-1/4"
CB8300-3672-040	3672-1	32-1/4"
CB8300-4236-040	4236-1	14-1/4"
CB8300-4240-040	4240-1	16-1/4"
CB8300-4248-040	4248-1	20-1/4"
CB8300-4254-040	4254-1	23-1/4"
CB8300-4260-040	4260-1	26-1/4"
CB8300-4266-040	4266-1	29-1/4"
CB8300-4272-040	4272-1	32-1/4"

**CB1050 Balance**

1/2" Wide x 1/2" Depth

**Inverted Tilt**

Please indicate required tilt shoe and clip, shown below:

Indicate  
Factory  
Numbers  
or Letters  
Stamped  
On  
Balance  
Face



**Tilt Shoes**

7008

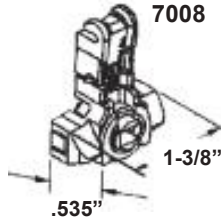

7066

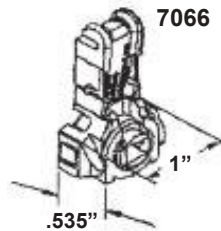

7003

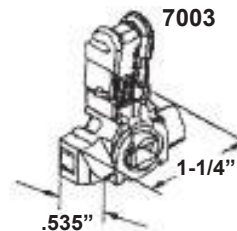

**Clips**

522

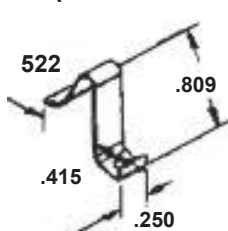

535

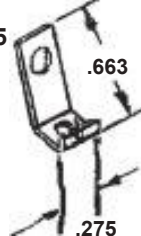

2799

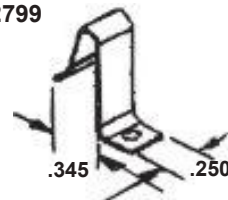

5400

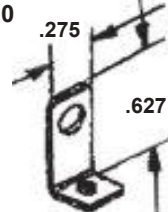

**9/16" channel width  
Non Ribbed  
(for ribbed channel - used in jamb liners - see CB 6 series)**

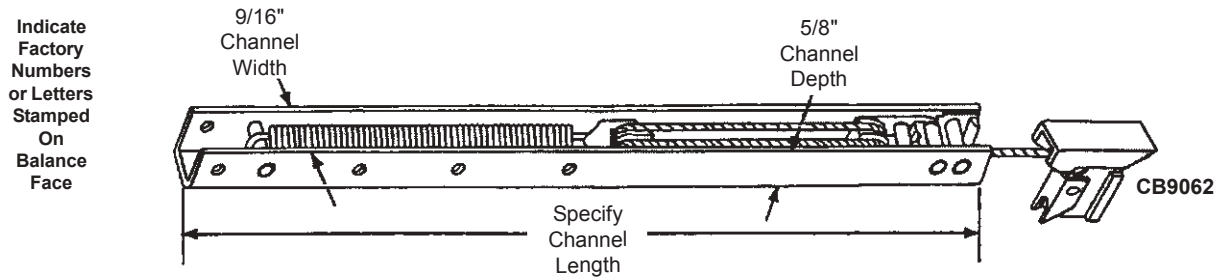

**Ordering Information**

1. Measure metal channel length (do not include any attached end guides).
2. Locate number stamped on balance (e.g. 1410, 2510, 26A, etc. . .)
3. Refer to chart , below, to locate the proper balance that corresponds to the numbers.

**Come with CB9062 end bracket, as shown**

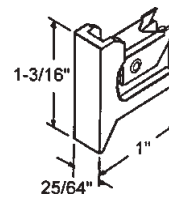

**White with metal cleat  
CB9062**

**Example**

Length of Metal Channel	No. Stamped on Balance	Blaine Part No.
19	1810	CB2018

Length of Metal Channel	No. Stamped On Bal.	Blaine Part Number	No. Stamped On Bal.	Blaine Part Number	No. Stamped On Bal.	Blaine Part Number	No. Stamped On Bal.	Blaine Part Number
13	1210 or 13A	CB2001-040	1220 or 13B	CB2001-13B	1230 or 13C	CB2001-13C	1240 or 13D	CB2002-040
14	1310 or 14A	CB2003-040	1320 or 14B	CB2004-040	1330 or 14C	CB2004-14C	1340 or 14D	CB2005-040
15	1410 or 15A	CB2006-040	1420 or 15B	CB2007-040	1430 or 15C	CB2007-15C	1440 or 15D	CB2008-040
16	1510 or 16A	CB2009-040	1520 or 16B	CB2010-040	1530 or 16C	CB2010-16C	1540 or 16D	CB2011-040
17	1610 or 17A	CB2012-040	1620 or 17B	CB2013-040	1630 or 17C	CB2013-17C	1640 or 17D	CB2014-040
18	1710 or 18A	CB2015-040	1720 or 18B	CB2016-040	1730 or 18C	CB2016-18C	1740 or 18D	CB2017-040
19	1810 or 19A	CB2018-040	1820 or 19B	CB2019-040	1830 or 19C	CB2019-19C	1840 or 19D	CB2020-040
20	1910 or 20A	CB2021-040	1920 or 20B	CB2022-040	1930 or 20C	CB2022-20C	1940 or 20D	CB2024-040
21	2010 or 21A	CB2025-040	2020 or 21B	CB2026-040	2030 or 21C	CB2027-040	2040 or 21D	CB2028-040
22	2110 or 22A	CB2029-040	2120 or 22B	CB2030-040	2130 or 22C	CB2031-040	2140 or 22D	CB2032-040
23	2210 or 23A	CB2033-040	2220 or 23B	CB2034-040	2230 or 23C	CB2035-040	2240 or 23D	CB2036-040
24	2310 or 24A	CB2037-040	2320 or 24B	CB2038-040	2330 or 24C	CB2039-040	2340 or 24D	CB2040-040
25	2410 or 25A	CB2041-040	2420 or 25B	CB2042-040	2430 or 25C	CB2043-040	2440 or 25D	CB2044-040
26	2510 or 26A	CB2045-040	2520 or 26B	CB2046-040	2530 or 26C	CB2047-040	2540 or 26D	CB2048-040
27	2610 or 27A	CB2049-040	2620 or 27B	CB2050-040	2630 or 27C	CB2051-040	2640 or 27D	CB2052-040
28	2710 or 28A	CB2053-040	2720 or 28B	CB2054-040	2730 or 28C	CB2055-040	2740 or 28D	CB2056-040
29	2810 or 29A	CB2057-040	2820 or 29B	CB2058-040	2830 or 29C	CB2059-040	2840 or 29D	CB2060-040
30	2910 or 30A	CB2061-040	2920 or 30B	CB2062-040	2930 or 30C	CB2063-040	2940 or 30D	CB2064-040
31	3010 or 31A	CB2065-040	3020 or 31B	CB2066-040	3030 or 31C	CB2067-040	3040 or 31D	CB2068-040
32	3110 or 32A	CB2069-040	3120 or 32B	CB2070-040	3130 or 32C	CB2071-040	3140 or 32D	CB2072-040
33	3210 or 33A	CB2073-040	3220 or 33B	CB2074-040	3230 or 33C	CB2075-040	3240 or 33D	CB2076-040
34	3310 or 34A	CB2077-040	3320 or 34B	CB2078-040	3330 or 34C	CB2079-040	3340 or 34D	CB2080-040
35	3410 or 35A	CB2081-040	3420 or 35B	CB2082-040	3430 or 35C	CB2083-040	3440 or 35D	CB2084-040
36	3510 or 36A	CB2085-040	3520 or 36B	CB2086-040	3530 or 36C	CB2087-040	3540 or 36D	CB2088-040
37	3610 or 37A	CB2089-040	3620 or 37B	CB2090-040	3630 or 37C	CB2091-040	3640 or 37D	CB2092-040
38	3710 or 38A	CB2093-040	3720 or 38B	CB2094-040	3730 or 38C	CB2095-040	3740 or 38D	CB2096-040
39	3810 or 39A	CB2097-040	3820 or 39B	CB2098-040	3830 or 39C	CB2098-39C	3840 or 39D	CB2098-39D
40	3910 or 40A	CB2098-40A	3920 or 40B	CB2098-40B	3930 or 40C	CB2098-40C	3940 or 40D	CB2098-40D
41	4010 or 41A	CB2098-41A	4020 or 41B	CB2098-41B	4030 or 41C	CB2098-41C	4040 or 41D	CB2098-41D
42	4110 or 42A	CB2098-42A	4120 or 42B	CB2098-42B	4130 or 42C	CB2098-42C	4140 or 42D	CB2098-42D
43	4210 or 43A	CB2098-43A	4220 or 43B	CB2098-43B	4230 or 43C	CB2098-43C	4240 or 43D	CB2098-43D
44	4310 or 44A	CB2098-44A	4320 or 44B	CB2098-44B	4330 or 44C	CB2099-040	4340 or 44D	CB2098-44D

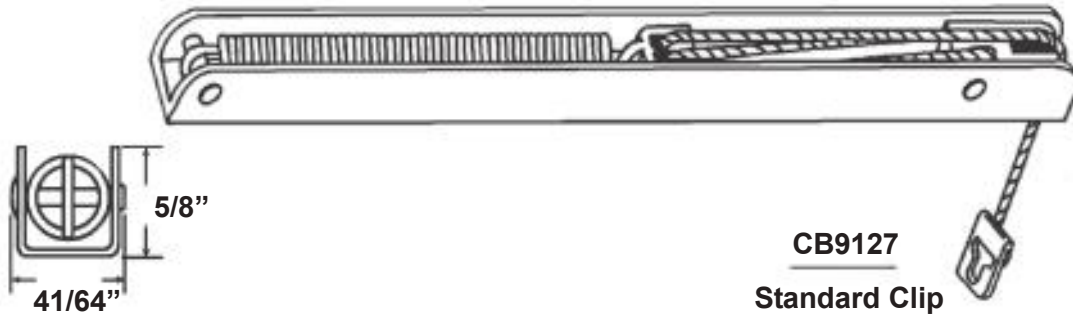

Blaine Part No.	No. Stamped on Balance	Length of Channel	Std. Cord Length From Balance*	Std. Wt/ Pair
CB1010-111-040	111	12-3/4"	20"	4 - 7 lbs
CB1010-112-040	112	12-3/4"	20"	7 - 11 lbs
CB1010-121-040	121	15-1/4"	25"	4 - 8 lbs
CB1010-122-040	122	15-1/4"	25"	8 - 12 lbs
CB1010-151-040	151	19-1/4"	33"	5 - 9 lbs
CB1010-152-040	152	19-1/4"	33"	9 - 13 lbs
CB1010-153-040	153	19-1/4"	33"	13 - 16 lbs
CB1010-162-040	162	23-1/4"	36"	9 - 14 lbs
CB1010-163-040	163	23-1/4"	36"	13 - 16 lbs
CB1010-163HD-040	163HD	23-1/4"	36"	15 - 17 lbs
CB1010-183-040	183	27-1/4"	40"	17 - 20 lbs
CB1010-183HD-040	183HD	27-1/4"	40"	24 - 27 lbs

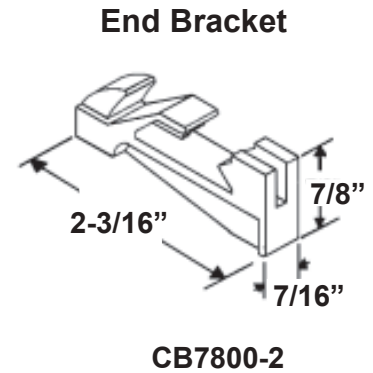

\*Note: If cord lengths are different from the standard lengths shown, a plus sign (+) and the extra number of inches should be added after the part number.

Ordering Information

1. Measure metal channel length.
2. Identify number stamped on balance.
3. Select our corresponding part number from the chart, above and order accordingly.
4. Standard clip will be attached unless otherwise specified.

Channel Height

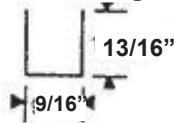

Channel Width

9/16" X 13/16"



Old style is slotted.  
New style is not.



Bottom View

**CB1100 "A" Type**

Glass Height	Length of Channel	Balance No.	Sash Wt/ Pair	Std. Cord Lngth	Blaine Part No.
12"	13-1/2"	101	5 - 7 lbs	31"	CB1100-101-040
12"	13-1/2"	102	7 - 11 lbs	31"	CB1100-102-040
14"	15-1/2"	111	5 - 8 lbs	33"	CB1100-111-040
14"	15-1/2"	112	8 - 11 lbs	33"	CB1100-112-040
16"	17-1/2"	121	5 - 9 lbs	35"	CB1100-121-040
16"	17-1/2"	122	9 - 12 lbs	35"	CB1100-122-040
18"	19-1/2"	131	5 - 9 lbs	37"	CB1100-131-040
18"	19-1/2"	132	9 - 13 lbs	37"	CB1100-132-040
20"	21-1/2"	141	5 - 9 lbs	39"	CB1100-141-040
20"	21-1/2"	142	9 - 12 lbs	39"	CB1100-142-040
20"	21-1/2"	143	12 - 14 lbs	39"	CB1100-143-040
22"	23-1/2"	151	6 - 10 lbs	41"	CB1100-151-040
22"	23-1/2"	152	10 - 12 lbs	41"	CB1100-152-040
22"	23-1/2"	153	12 - 15 lbs	41"	CB1100-153-040
24"	25-1/2"	161	6 - 10 lbs	43"	CB1100-161-040
24"	25-1/2"	162	10 - 14 lbs	43"	CB1100-162-040
24"	25-1/2"	163	14 - 18 lbs	43"	CB1100-163-040
26"	27-1/2"	171	6 - 10 lbs	45"	CB1100-171-040
26"	27-1/2"	172	10 - 14 lbs	45"	CB1100-172-040
26"	27-1/2"	173	14 - 18 lbs	45"	CB1100-173-040
28"	29-1/2"	181	7 - 12 lbs	47"	CB1100-181-040
28"	29-1/2"	182	12 - 16 lbs	47"	CB1100-182-040
28"	29-1/2"	183	16 - 20 lbs	47"	CB1100-183-040
30"	31-1/2"	191	7 - 12 lbs	49"	CB1100-191-040
30"	31-1/2"	192	12 - 16 lbs	49"	CB1100-192-040
30"	31-1/2"	193	16 - 20 lbs	49"	CB1100-193-040
32"	33-1/2"	201	8 - 14 lbs	51"	CB1100-201-040
32"	33-1/2"	202	14 - 18 lbs	51"	CB1100-202-040
32"	33-1/2"	203	18 - 22 lbs	51"	CB1100-203-040
34"	35-1/2"	211	8 - 14 lbs	53"	CB1100-211-040
34"	35-1/2"	212	14 - 18 lbs	53"	CB1100-212-040
34"	35-1/2"	213	18 - 22 lbs	53"	CB1100-213-040
36"	37-1/2"	221	8 - 15 lbs	55"	CB1100-221-040
36"	37-1/2"	222	15 - 20 lbs	55"	CB1100-222-040
36"	37-1/2"	223	20 - 24 lbs	55"	CB1100-223-040
38"	37-1/2"	231	8 - 15 lbs	57"	CB1100-231-040
38"	37-1/2"	232	15 - 20 lbs	57"	CB1100-232-040
38"	37-1/2"	233	20 - 24 lbs	57"	CB1100-233-040
40"	37-1/2"	241	8 - 15 lbs	59"	CB1100-241-040
40"	37-1/2"	242	15 - 20 lbs	59"	CB1100-242-040
40"	37-1/2"	243	20 - 24 lbs	59"	CB1100-243-040
42"	37-1/2"	251	8 - 15 lbs	61"	CB1100-251-040
42"	37-1/2"	252	15 - 20 lbs	61"	CB1100-252-040
42"	37-1/2"	253	20 - 24 lbs	61"	CB1100-253-040

**CB1150 "AX" Type**

Glass Height	Length of Channel	Balance No.	Sash Wt/ Pair	Std. Cord Length	Blaine Part No.
12"	13-1/2"	101AX	11 - 16 lb	31"	CB1150-AX101-050
12"	13-1/2"	102AX	16 - 24 lb	31"	CB1150-AX102-050
14"	15-1/2"	111AX	11 - 16 lb	33"	CB1150-AX111-050
14"	15-1/2"	112AX	16 - 25 lb	33"	CB1150-AX112-050
16"	17-1/2"	121AX	12 - 19 lb	35"	CB1150-AX121-050
16"	17-1/2"	122AX	19 - 26 lb	35"	CB1150-AX122-050
18"	19-1/2"	131AX	13 - 19 lb	37"	CB1150-AX131-050
18"	19-1/2"	132AX	19 - 26 lb	37"	CB1150-AX132-050
20"	21-1/2"	141AX	14 - 20 lb	39"	CB1150-AX141-050
20"	21-1/2"	142AX	20 - 26 lb	39"	CB1150-AX142-050
20"	21-1/2"	143AX	26 - 30 lb	39"	CB1150-AX143-050
22"	23-1/2"	151AX	15 - 20 lb	41"	CB1150-AX151-050
22"	23-1/2"	152AX	20 - 26 lb	41"	CB1150-AX152-050
22"	23-1/2"	153AX	26 - 32 lb	41"	CB1150-AX153-050
24"	25-1/2"	161AX	18 - 23 lb	43"	CB1150-AX161-050
24"	25-1/2"	162AX	23 - 28 lb	43"	CB1150-AX162-050
24"	25-1/2"	163AX	28 - 34 lb	43"	CB1150-AX163-050
24"	25-1/2"	164AX	34 - 38 lb	43"	CB1150-AX164-050
26"	27-1/2"	171AX	18 - 23 lb	45"	CB1150-AX171-050
26"	27-1/2"	172AX	23 - 28 lb	45"	CB1150-AX172-050
26"	27-1/2"	173AX	28 - 34 lb	45"	CB1150-AX173-050
26"	27-1/2"	174AX	34 - 38 lb	45"	CB1150-AX174-050
28"	29-1/2"	181AX	20 - 25 lb	47"	CB1150-AX181-050
28"	29-1/2"	182AX	25 - 32 lb	47"	CB1150-AX182-050
28"	29-1/2"	183AX	32 - 38 lb	47"	CB1150-AX183-050
28"	29-1/2"	184AX	38 - 42 lb	47"	CB1150-AX184-050
30"	31-1/2"	191AX	20 - 25 lb	49"	CB1150-AX191-050
30"	31-1/2"	192AX	25 - 32 lb	49"	CB1150-AX192-050
30"	31-1/2"	193AX	32 - 38 lb	49"	CB1150-AX193-050
30"	31-1/2"	194AX	38 - 42 lb	49"	CB1150-AX194-050
32"	33-1/2"	201AX	22 - 28 lb	51"	CB1150-AX201-050
32"	33-1/2"	202AX	28 - 34 lb	51"	CB1150-AX202-050
32"	33-1/2"	203AX	34 - 40 lb	51"	CB1150-AX203-050
32"	33-1/2"	204AX	40 - 44 lb	51"	CB1150-AX204-050
34"	35-1/2"	211AX	24 - 30 lb	53"	CB1150-AX211-050
34"	35-1/2"	212AX	30 - 36 lb	53"	CB1150-AX212-050
34"	35-1/2"	213AX	36 - 42 lb	53"	CB1150-AX213-050
34"	35-1/2"	214AX	42 - 48 lb	53"	CB1150-AX214-050
36"	37-1/2"	221AX	24 - 30 lb	55"	CB1150-AX221-050
36"	37-1/2"	222AX	30 - 36 lb	55"	CB1150-AX222-050
36"	37-1/2"	223AX	36 - 42 lb	55"	CB1150-AX223-050
36"	37-1/2"	224AX	42 - 48 lb	55"	CB1150-AX224-050
38"	37-1/2"	231AX	24 - 30 lb	57"	CB1150-AX231-050
38"	37-1/2"	232AX	30 - 36 lb	57"	CB1150-AX232-050
38"	37-1/2"	233AX	36 - 42 lb	57"	CB1150-AX233-050
38"	37-1/2"	234AX	42 - 48 lb	57"	CB1150-AX234-050
40"	37-1/2"	241AX	24 - 30 lb	59"	CB1150-AX241-050
40"	37-1/2"	242AX	30 - 36 lb	59"	CB1150-AX242-050
40"	37-1/2"	243AX	36 - 42 lb	59"	CB1150-AX243-050
40"	37-1/2"	244AX	42 - 48 lb	59"	CB1150-AX244-050
42"	37-1/2"	251AX	24 - 30 lb	61"	CB1150-AX251-050
42"	37-1/2"	252AX	30 - 36 lb	61"	CB1150-AX252-050
42"	37-1/2"	253AX	36 - 42 lb	61"	CB1150-AX253-050
42"	37-1/2"	254AX	42 - 48 lb	61"	CB1150-AX254-050

**CB1200 Series Bantam  
Overhead Balance**

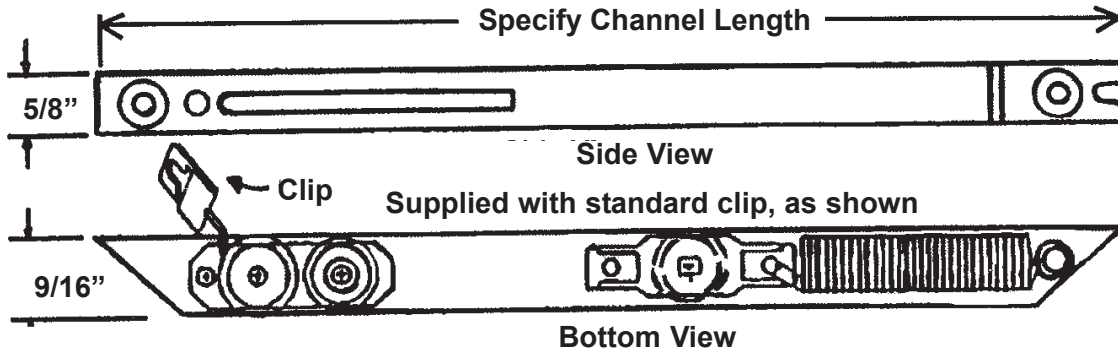

Blaine Part No.	No. Stamped On Balance	Channel Length	Sash Wt. Lbs
CB1200-101-040	101B	12-1/2"	5 - 7
CB1200-102-040	102B	12-1/2"	7 - 11
CB1200-102HD-040	102BHD	12-1/2"	11 - 13
CB1200-111-040	111B	14-1/2"	5 - 8
CB1200-112-040	112B	14-1/2"	8 - 11
CB1200-112HD-040	112BHD	14-1/2"	11 - 16
CB1200-121-040	121B	16-1/2"	5 - 9
CB1200-122-040	122B	16-1/2"	9 - 12
CB1200-122HD-040	122BHD	16-1/2"	12 - 16
CB1200-141-040	141B	20-1/2"	5 - 9
CB1200-142-040	142B	20-1/2"	9 - 12
CB1200-143-040	143B	20-1/2"	12 - 14
CB1200-142HD-040	142BHD	20-1/2"	14 - 20
CB1200-161-040	161B	24-1/2"	6 - 10
CB1200-162-040	162B	24-1/2"	10 - 14
CB1200-163-040	163B	24-1/2"	14 - 16
CB1200-163HD-040	163BHD	24-1/2"	18 - 24
CB1200-181-040	181B	28-1/2"	7 - 12
CB1200-182-040	182B	28-1/2"	12 - 16
CB1200-183-040	183B	28-1/2"	16 - 20
CB1200-183HD-040	183BHD	28-1/2"	20 - 30
CB1200-201-040	201B	32-1/2"	8 - 14
CB1200-202-040	202B	32-1/2"	14 - 18
CB1200-203-040	203B	32-1/2"	18 - 22
CB1200-203HD-040	203BHD	32-1/2"	22 - 30
CB1200-221-040	221B	36-1/2"	8 - 15
CB1200-222-040	222B	36-1/2"	15 - 20
CB1200-223-040	223B	36-1/2"	20 - 24
CB1200-223HD-040	223BHD	36-1/2"	24 - 34

**1/2" RIBBED CHANNEL BALANCE FOR JAMBLINERS**



Ribbed Balance

CB9295  
comes standard



End view of channel shape of ribbed balances.

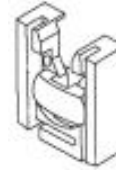

CB9278  
Sold separately

**Ordering Information**

1. Measure metal channel length. Do not include any attached ends.
2. Check number stamped on channel (e.g., 16, 16HD, 16TG, etc. . .)
3. Select our corresponding part numbers from the chart below.

**General Instructions**

1. In order to remove balances, you must remove all window trim and remove sash along with jambliners. Balances can then be slid out of jambliner sleeve, once parts are moved to the release position. Please note that forcing balances out of jambliner pocket will most likely destroy vinyl extrusion.
2. Balances can be special ordered in beige or white finishes. Contact Customer Service for assistance.

Standard is aluminum

Length of Metal Channel	No. Stamped On Bal.	Blaine Part Number	Length of Metal Channel	No. Stamped On Bal.	Blaine Part Number
13"	12 or 12R	CB7412Reg-040	30"	29 or 29R	CB7429Reg-040
13	12HD	CB7412HD-040	30"	29HD	CB7429HD-040
14"	13 or 13R	CB7413Reg-040	30"	29TG or 29XHD	CB7429XH-040
14"	13HD	CB7413HD-040	31"	30 or 30R	CB7430Reg-040
15"	14 or 14R	CB7414Reg-040	31"	30HD	CB7430HD-040
15"	14HD	CB7414HD-040	31"	30TG or 30XHD	CB7430XH-040
16"	15 or 15R	CB7415Reg-040	32"	31 or 31R	CB7431Reg-040
16"	15HD	CB7415HD-040	32"	31HD	CB7431HD-040
17"	16 or 16R	CB7416Reg-040	32"	31TG or 31XHD	CB7431XH-040
17"	16HD	CB7416HD-040	33"	32 OR 32R	CB7432Reg-040
18"	17 or 17R	CB7417Reg-040	33"	32HD	CB7432HD-040
18"	17HD	CB7417HD-040	33"	32TG OR 32XHD	CB7432XH-040
19"	18 or 18R	CB7418Reg-040	34"	33 OR 33R	CB7433Reg-040
19"	18HD	CB7418HD-040	34"	33HD	CB7433HD-040
20"	19 or 19R	CB7419Reg-040	34"	33TG OR 33XHD	CB7433XH-040
20"	19HD	CB7419HD-040	35"	34 OR 34R	CB7434Reg-040
21"	20 or 20R	CB7420Reg-040	35"	34HD	CB7434HD-040
21"	20HD	CB7420HD-040	35"	34TG OR 34XHD	CB7434XH-040
21"	20TG or 20XHD	CB7420XH-040	36"	35 OR 35R	CB7435Reg-040
22"	21 or 21R	CB7421Reg-040	36"	35HD	CB7435HD-040
22"	21HD	CB7421HD-040	36"	35TG OR 35XHD	CB7435XH-040
22"	21TG or 21XHD	CB7421XH-040	37"	36 OR 36R	CB7436Reg-040
23"	22 or 22R	CB7422Reg-040	37"	36HD	CB7436HD-040
23"	22 HD	CB7422HD-040	37"	36TG OR 36XHD	CB7436XH-040
23"	22TG or 22XHD	CB7422XH-040	38"	37 OR 37R	CB7437Reg-040
24"	23 or 23R	CB7423Reg-040	38"	37HD	CB7437HD-040
24"	23HD	CB7423HD-040	38"	37TG OR 37XHD	CB7437XH-040
24"	23TG or 23XHD	CB7423XH-040	39"	38 OR 38R	CB7438Reg-040
25"	24 or 24R	CB7424Reg-040	39"	38HD	CB7438HD-040
25"	24HD	CB7424HD-040	39"	38TG OR 38XHD	CB7438XH-040
25"	24TG or 24XHD	CB7424XH-040	40"	39 OR 39R	CB7439Reg-040
26"	25 or 25R	CB7425Reg-040	40"	39HD	CN7439HD-040
26"	25HD	CB7425HD-040	40"	39TG OR 39XHD	CB7439XH-040
26"	25TG or 25XHD	CB7425XH-040	41"	40 OR 40R	CB7440Reg-040
27"	26 or 26R	CB7426Reg-040	41"	40HD	CB7440HD-040
27"	26HD	CB7426HD-040	41"	40TG OR 40XHD	CB7440XH-040
27"	26TG or 26XHD	CB7426XH-040	42"	41 OR 41R	CB7441Reg-040
28"	27 or 27R	CB7427Reg-040	42"	41HD	CB7441HD-040
28"	27HD	CB7427HD-040	42"	41TG OR 41XHD	CB7441XH-040
28"	27TG or 27XHD	CB7427XH-040	43"	42 OR 42R	CB7442Reg-040
29"	28 or 28R	CB7428Reg-040	43"	42HD	CB7442HD-040
29"	28HD	CB7428HD-040	43"	42TG OR 42XHD	CB7442XH-040
29"	28TG or 28XHD	CB7428XH-040			



**CB8200 Series Overhead Balance**

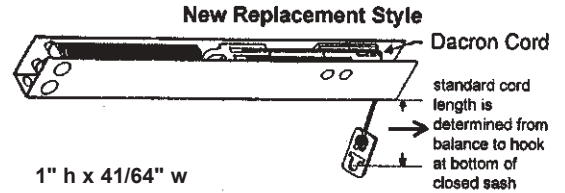
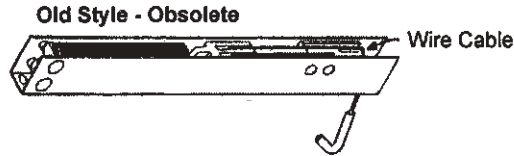

BLAINE PART NO.	NO. STAMPED ON BALANCE	CHANNEL LENGTH	STD CORD LENGTH FROM BALANCE	SASH WEIGHT (2) BALANCES
CB8200-112-040	112	13-1/4"	20"	4 - 10
CB8200-112D-040	112D	13-1/4"	20"	10 - 18
CB8200-122-040	122	16-1/4"	25"	6 - 12
CB8200-122D-040	122D	16-1/4"	25"	12 - 22
CB8200-153-040	153	19-3/4"	30"	8 - 16
CB8200-153D-040	153D	19-3/4"	30"	16 - 28
CB8200-163-040	163	23-3/4"	36"	10 - 18
CB8200-163D-040	163D	23-3/4"	36"	18 - 32
CB8200-183-040	183	28-1/4"	40"	10 - 16
CB8200-183D-040	183D	28-1/4"	40"	16 - 34

CB9097-1 Bracket

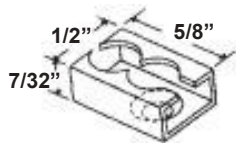

**CB8900 SERIES DEVAC OVERHEAD BALANCE**



works with CB9097-1 bracket, shown above

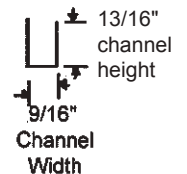
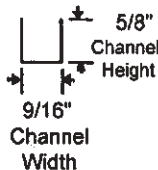

BLAINE PART NO.	OLD NO. ON BALANCE	NEW NO. ON BALANCE	CHANNEL LENGTH	STD CORD LENGTH FROM BALANCE
CB8900-1210HD	111	1210HD	13"	31"
CB8900-1220HD	112	1220HD	13"	31"
CB8900-112D	112-D	112D	13-1/4"	36"
CB8900-1510HD	121	1510HD	16"	37"
CB8900-1520HD	122	1520HD	16"	37"
CB8900-122D	122-D	122-D	16-1/4"	42"
CB8900-1910HD	151	1910HD	20"	41"
CB8900-1920HD	152	1920HD	20"	41"
CB8900-1930HD	153	1930HD	20"	41"
CB8900-153D	153-D	153-D	19-3/4"	47"
CB8900-2320HD	162	2320HD	24"	47"
CB8900-2330HD	163	2330HD	24"	47"
CB8900-163D	163-D	163-D	23-3/4"	53"
CB8900-2730HD	183	2730HD	28"	50"
CB8900-183D	183-D	183-D	28-1/4"	58"

Standard cord length is determined from balance to hook at bottom of closed sash.

**TOP GUIDES**

<p><b>CB9006</b> White Top Guide</p>	<p><b>CB9007</b> White Top Guide</p>	<p><b>CB9269</b> White Top Guide</p>	<p><b>CB9250</b> Top Guide White</p>
<p><b>CB9085</b> White Top Guide</p>	<p><b>CB9001-1</b> Capitol White Top Guide</p>	<p><b>CB9268-A</b> Top Guide Black or white</p>	<p><b>CB9088</b> Black or white TOP</p>

**SASH CAMS**

<p><b>CB9012</b> Black or white</p>	<p><b>CB9030</b> White High Crown</p>	<p><b>CB9031</b> White</p>	<p><b>CB9033</b> White</p>
---	---	--------------------------------	--------------------------------

<p><b>CB9067</b> Black or white</p>	<p><b>CB9087</b> Black or white</p>	<p><b>CB9312</b> Black or white</p>
---	---	---

<p><b>CB9252-Spec</b> White</p>	<p><b>CB9264</b> Black or white</p>	<p><b>CB9308</b> Black or white</p>
-------------------------------------	---	---

**SASH CAMS**

<p><b>CB9304-L/R</b> Black</p>	<p><b>CB9035</b> White</p>	<p><b>CB9077</b> white nylon</p>	<p><b>CB9341</b> White</p>
<p><b>CB9096</b></p> <p>Black or white</p>	<p><b>CB9065</b></p> <p>Black or white</p>	<p><b>CB9340</b></p> <p>Black</p>	<p><b>CB9091</b></p> <p>Black or white</p>
<p><b>CB9078</b> Black</p>	<p><b>CB9433-L/R</b> Black</p>		<p><b>CB9068</b> White Nylon Sash Cam</p>
<p><b>CB9098</b> <b>Fiberlux</b> Black, brown or white</p>	<p><b>CB9265</b> Black or white</p>	<p><b>CB9290-L/R</b> RH &amp; LH Set</p>	<p><b>CB9289-L/R</b> RH &amp; LH Set Black</p>
<p><b>CB9309</b> Black</p>	<p><b>CB9269</b> Black or white</p>	<p><b>CB9329</b> Black or White</p>	<p><b>CB9375</b> Black or White Sold L/R Pair</p>

**SASH CAMS**

<p><b>CB9397</b></p> <p>White</p>	<p><b>CB9011</b></p> <p>White</p>	<p><b>CB9335</b></p> <p>White</p>	<p><b>CB9018</b></p> <p>Black &amp; White</p>
<p><b>CB9338</b></p>	<p><b>CB9398</b></p> <p>White</p>	<p><b>CB9255</b></p> <p>Black or White</p>	<p><b>CB9274</b></p> <p>Black</p> <p><b>EFCO CAM</b></p>
<p><b>CB9266</b></p> <p>Rollyson</p> <p>Black or White</p>	<p><b>CB9257</b></p> <p>Aluminum</p>	<p><b>CB9276</b></p> <p>Aluminum</p>	<p><b>CB9395</b></p> <p>White</p> <p>King</p>

**MISCELLANEOUS**

<p><b>CB9394</b></p> <p>Used when no rivet tool is available or if parts are stocked without ends attached.</p>	<p><b>CB9010</b></p> <p>Steel</p>	<p><b>CB9013</b></p> <p>Steel</p>	<p><b>CB9353</b></p> <p>Aluminum</p> <p>Sponge Rubber</p>
<p><b>CB9348</b></p> <p>White</p> <p>Felt</p>	<p><b>CB9256</b></p> <p>Louisiana Pacific</p> <p>White or Black</p> <p>3 Piece</p>	<p><b>CB9256-F</b></p> <p>Flip Latch</p> <p>Cast Metal</p>	

<p><b>CB9046</b></p> <p>White</p> <p>TOP</p> <p>BOTTOM</p>	<p><b>CB9291</b></p> <p>White</p> <p>TOP</p>	<p><b>CB9021</b></p> <p>Includes two(2) of each parts shown, plus two (2) screws</p>	
<p><b>CB9268-A</b></p> <p>TOP</p> <p>Black or white</p>	<p><b>CB9268-B</b></p> <p>Original in clear plastic</p> <p>TOP</p> <p>BOTTOM</p> <p>Black or white</p>	<p>White</p>	
<p><b>CB9048</b></p> <p>White</p> <p>TOP</p> <p>Bottom</p> <p>Top &amp; Bottom guide</p> <p>This pc. also sold separately as</p>	<p><b>CB9028-Assy</b></p> <p>White</p> <p>TOP</p>	<p><b>CB9056</b></p> <p>White</p> <p>BOTTOM</p>	
<p><b>CB9049</b></p> <p><b>BOTTOM GUIDES</b></p>			
<p><b>CB9002</b></p> <p>White</p> <p>BOTTOM</p>	<p><b>CB9003</b></p> <p>White</p> <p>BOTTOM</p>	<p><b>CB9004</b></p> <p>White</p> <p>BOTTOM</p>	<p><b>CB9023</b></p> <p>White</p> <p>BOTTOM</p>
<p><b>CB9005</b></p> <p>White</p> <p>BOTTOM</p>	<p><b>CB9014</b></p> <p>White</p> <p>Bottom Guide</p>	<p><b>CB9015</b></p> <p>White</p> <p>BOTTOM</p>	<p><b>CB9019</b></p> <p>White</p> <p>BOTTOM</p>

**CB 0 SERIES COMBINATIONS**

<p><b>CB9006</b> Top</p> <p>White</p>	<p><b>CB9003</b> Bottom</p> <p>White</p>	<p><b>CB9006</b> Top</p> <p>White</p>	<p><b>CB9004</b> Bottom</p> <p>White</p>
<p><b>CB9007</b> White</p> <p>Top</p>	<p><b>CB9005</b> Bottom</p> <p>White</p>	<p><b>CB9051-Set</b></p> <p>White TOP BOTTOM White</p>	
<p><b>CB9019</b></p> <p>Bottom White</p>	<p><b>CB9020</b></p> <p>White</p> <p>TOP</p>	<p><b>CB9001-1</b></p> <p>TOP White</p>	<p><b>CB9002</b></p> <p>BOTTOM</p>
<p><b>CB9025</b></p> <p>Top White</p>	<p><b>CB9029</b></p> <p>White</p> <p>Bottom</p>	<p><b>CB9075-B</b></p> <p>Bottom Usually Black</p>	<p><b>CB9075-A</b></p> <p>Top</p> <p>Black</p>
<p><b>CB9104-Top</b></p>	<p><b>CB9104-Bottom</b></p>	<p><b>CB9075</b></p>	
<p>Top &amp; Bottom Guide White Nylon</p>			

**CB 4 SERIES**

<p><b>CB9071</b> <b>Top Guide</b> White</p>	<p><b>CB9040</b> <b>Top Guide</b> White</p>	<p><b>CB9041</b> <b>Bottom Guide</b> White</p>	<p><b>CB9042</b> White</p>
---	---	--	--------------------------------

**CB 2 SERIES**

**CB 3 SERIES**

<p><b>CB9062</b></p> <p>White with metal cleat</p>	<p><b>CB9074</b> Available in white or cast metal</p>	<p><b>CB9228</b> order CB9229 brake shoe / pawl</p> <p>White</p>	<p><b>CB9083-L/R</b> White</p> <p>Left/Right Handed - Pair</p>
--	---	--	--

<p><b>CB9270</b></p> <p>L/R Pair</p>	<p><b>CB9270-1</b> Die Cast Metal</p> <p>order CB9270-2 pawl</p>	<p><b>CB9230</b> Pivot Retainer</p> <p>White</p>	<p><b>CB9229</b> Brake shoe for CB9228 Locking Terminal</p> <p>White</p>
--------------------------------------	--	--	--

**CB 5 SERIES**

<p><b>CB9249</b> Locking Terminal</p> <p>white</p>	<p><b>CB9246</b> Locking Cam</p> <p>Cast Zinc Metal</p>	<p><b>CB9263</b> Sash Pivot</p> <p>white</p>	<p><b>CB9208</b> white</p>
<p><b>CB9231</b> Cast zinc metal</p>	<p><b>CB9232</b> Cast zinc metal</p>	<p><b>CB9258</b> Top Tilt Pivot</p> <p>Cast Zinc Metal</p>	<p><b>CB9202</b> L/R Pair Cast zinc metal</p>
<p><b>CB9248</b> white or black</p>	<p><b>CB9225</b> Upper Latch White</p>	<p><b>CB9219</b> white</p> <p>.346" o.d. .174 i.d.</p>	<p><b>CB9207</b> white</p>

<p><b>CB9077</b></p> <p>5/8" 1-5/16" 7/8" white</p>	<p><b>CB9098</b> L/R Pair</p> <p>Black Brown &amp; White</p> <p>1-1/16" 1-1/4" 21/32" 1-51/64"</p>	<p><b>CB9202</b></p> <p>3/16" 3/8" 1-3/16" 1"</p> <p>Cast Zinc Metal</p> <p>L/R Pair</p>	<p><b>CB9208</b></p> <p>7/16" 5/16"</p> <p>white</p>
<p><b>CB9219</b> white</p> <p>1/4"</p> <p>.346" (approx. 11/32") o.d. .174" (approx. 11/64") i.d.</p>	<p><b>CB9225</b> Upper latch white nylon</p> <p>2-15/16" 5/16" 3/4"</p>	<p>The accessories shown on these pages are a representation of the thousands of balance accessories available through Blaine. Please contact our Customer Service Department at 1-800-678-1919 for assistance.</p>	<p><b>WB1360</b> cast zinc metal</p> <p>1-1/4" 3/16 x 5/16 x 2-1/2"</p>
<p><b>WB1361</b></p> <p>2" 1-3/8" 3/16 x 5/16 x 2-1/2"</p> <p>cast zinc metal</p>	<p><b>WB1362</b> cast zinc metal</p> <p>1-1/2" 3/16 x 5/16 x 2-1/2"</p>		<p><b>WB1363</b> cast zinc metal</p> <p>15/16" 3/16 x 5/16 x 2-1/2"</p>
<p><b>WB1365</b> cast zinc metal</p> <p>2" 1-3/8" 11/64" dia. holes</p>	<p><b>WB1366</b> cast zinc metal</p> <p>2" 1-3/8" 1-1/8" 3/16 x 5/16 x 2-1/2"</p>	<p><b>WB1367</b> cast zinc metal</p> <p>1-15/16" 1-1/2" 7/32" 3/16 x 5/16 x 2-1/2"</p>	<p><b>WB1368</b> cast zinc metal</p> <p>1-3/4" 2-27/32" 2" 1-3/8" 3/16 x 5/16 x 3"</p>
<p><b>WB1302</b> cast zinc metal</p> <p>1-3/4" 1" 11/64" x 19/64" x 2-61/64"</p>	<p><b>WB1305</b> 8-32 threads Stainless Steel</p> <p>1-1/64" 3/16 x 5/16 x 3</p> <p>Order WB1305-Screw Separately Order WB1305-Hex Key Separately</p>	<p><b>WB1317</b> cast zinc metal</p> <p>2-5/8" 1-5/8" 3/16 x 9/32" 3-7/32"</p>	<p><b>WB1371</b></p> <p>2-3/8" 5/32" 1/2" 3/8" 1/4"</p>
<p><b>WB1374</b></p> <p>1" 2-7/8" 1/4" 3/16"</p>	<p><b>WB1380</b></p> <p>1-1/4" 2-5/8" 5/32" 7/8"</p>	<p><b>WB1383</b></p> <p>1/4" 1-3/4" 1/4" 2-7/16" 1-1/2"</p>	<p><b>WB1387</b></p> <p>2-13/16" 9/16" 5/16" 3/32" 3/8"</p>



**For Single Strength Glass**

Glass Size	Opening Height	1-3/8" Part No.	1-1/4" Part No.	Max. Sash Weight	Length At Longest Point
12"	2-6 - 30"	WB7101	WB7101-A	7.8 LBS	30-3/16"
14"	2-10 - 34"	WB7102	WB7102-A	8.5 LBS	34-3/16"
16"	3-2 - 38"	WB7103	WB7103-A	9.2 LBS	38-3/16"
18"	3-6 - 42"	WB7104	WB7104-A	9.9 LBS	42-3/16"
20"	3-10 - 46"	WB7105	WB7105-A	10.6 LBS	46-3/16"
22"	4-2 - 50"	WB7106	WB7106-A	11.3 LBS	50-3/16"
24"	4-6 - 54"	WB7107	WB7107-A	12.0 LBS	54-3/16"
26"	4-10 - 58"	WB7108	WB7108-A	12.7 LBS	58-3/16"
28"	5-2 - 62"	WB7109	WB7109-A	13.4 LBS	62-3/16"
30"	5-6 - 66"	WB7110	WB7110-A	14.1 LBS	66-3/16"
32"	5-10 - 70"	WB7111	WB7111-A	14.8 LBS	70-3/16"
34"	6-2 - 74"	WB7112	WB7112-A	15.5 LBS	74-3/16"
36"	6-6 - 78"	WB7113	WB7113-A	16.2 LBS	78-3/16"

**WB7100**  
for 1-3/8" sash

**WB7100-A**  
for 1-1/4" Sash

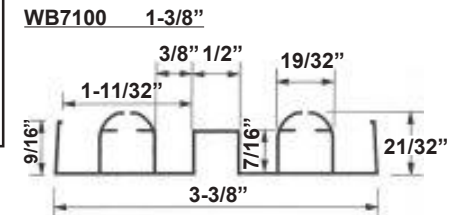
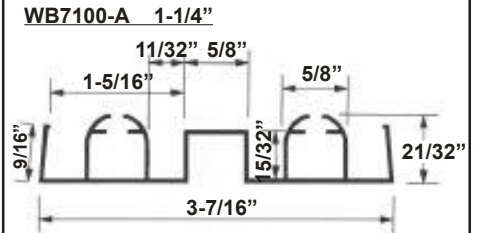

Only available in beige. 14 degree standard sill angle. Please contact Customer Service for more information or cottage, carriage and oriel windows.

**For Insulated or Double Strength Glass**

Glass Size	Opening Height	1-3/8" Part No.	1-1/4" Part No.	Max. Sash Weight	Length At Longest Point
12"	2-6 - 30"	WB7201	WB7201-A	11.0 LBS	30-3/16"
14"	2-10 - 34"	WB7202	WB7202-A	12.3 LBS	34-3/16"
16"	3-2 - 38"	WB7203	WB7203-A	13.5 LBS	38-3/16"
18"	3-6 - 42"	WB7204	WB7204-A	14.6 LBS	42-3/16"
20"	3-10 - 46"	WB7205	WB7205-A	16.0 LBS	46-3/16"
22"	4-2 - 50"	WB7206	WB7206-A	17.3 LBS	50-3/16"
24"	4-6 - 54"	WB7207	WB7207-A	18.5 LBS	54-3/16"
26"	4-10 - 58"	WB7208	WB7208-A	19.9 LBS	58-3/16"
28"	5-2 - 62"	WB7209	WB7209-A	21.0 LBS	62-3/16"
30"	5-6 - 66"	WB7210	WB7210-A	22.2 LBS	66-3/16"
32"	5-10 - 70"	WB7211	WB7211-A	23.5 LBS	70-3/16"
34"	6-2 - 74"	WB7212	WB7212-A	24.7 LBS	74-3/16"
36"	6-6 - 78"	WB7213	WB7213-A	26.0 LBS	78-3/16"

**WB7200**  
for 1-3/8" sash

**WB7200-A**  
for 1-1/4" Sash

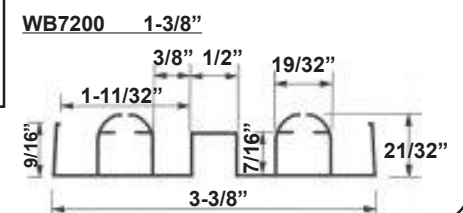
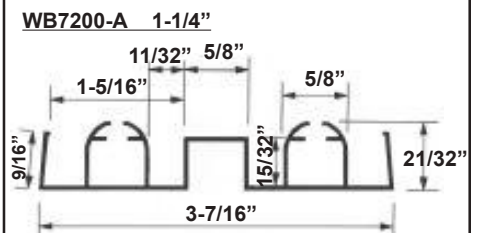

Only available in beige. 14 degree standard sill angle. Please contact Customer Service for more information or cottage, carriage and oriel windows.

**WB9200  
Constant Force Balance**

Single or Double Coil	No. Stamped on Coil	Blaine Part No.
Single	5 or 540	WB9200-Single - 5/540
Single	6 or 640	WB9200-Single - 6/640
Single	7 or 740	WB9200-Single - 7/740
Single	8 or 840	WB9200-Single - 8/840
Single	832	WB9200-Single - 832
Double	440 / 440	WB9200-Dbl - 440/440
Double	440 / 540	WB9200-Dbl - 440/540
Double	540 / 540	WB9200-Dbl - 540 / 540
Double	540 / 640	WB9200-Dbl - 540 / 640
Double	640 / 640	WB9200-Dbl - 640/640
Double	740 / 740	WB9200-Dbl - 740/740

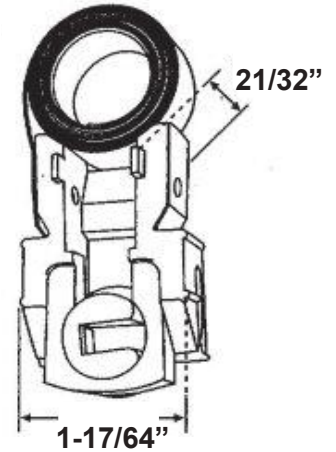

**WB9200 Bushing**

Color	Diameter	Blaine Part Number
Dark Gray	21/32"	WB9200-Bushing-DGRY
Black	21/32"	WB9200-Bushing-BLK
Bronze	41/64"	WB9200-Bushing-BRZ
Gray	11/16"	WB9200-Bushing-Gray
Tan	41/64"	WB9200-Bushing-TAN
White	43/64"	WB9200-Bushing-WHT

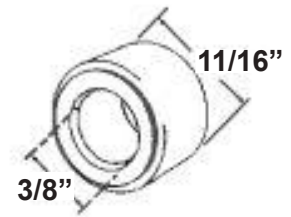

**WB9200- Clip-058**

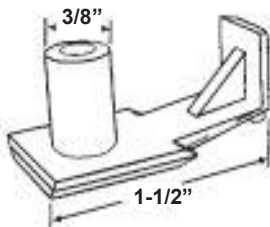

**WB9200 -Double Clip-058**

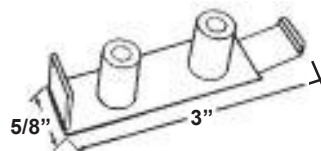

**WB9200- Guide-058**

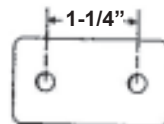

**Pivot Bar**

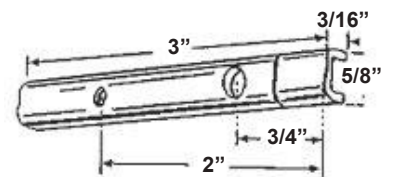

**WB1047-1-050**